

HAZİRAN 2026 FİYAT LİSTESİ



www.erkcelik.com.tr





2004 yılında, İstanbul'da faaliyete başlayan Erk Çelik: çelik halat, zincir ve halat ekleri, kaldırma ekipmanları, kişisel iş güvenliği ve milli sanayimizin ihtiyaç duyduğu endüstriyel ürünlerin tedariki konusunda ülkemizin öncü firmalarındandır.

Dünya devleriyle işbirliği yaparak, ülke kalkınmasına destek olan firmamız, kurumsal yapısını zamanın gereksinimlerine göre dizayn ederek gelişimini sürdürmektedir.

Erk Çelik, 5000 m2 depolama alanıyla, yerli ve yabancı yaklaşık 60 farklı tedarikçisiyle, 30 farklı sektörden 3000 kayıtlı iş ortağına, 36 çalışanı ile Türkiye'nin 7 bölgesinde 81 ilde pazarlama ve satış faaliyeti yapmaktadır.

ERK ÇELİK HALAT; 1 mm'den 88 mm'e kadar, farklı yapılar, 2500 ton çelik halat stoğu ile VEROPE, HASÇELİK, POWERK markalı halatları...

Farklı kalite ve kapasitelerde zincir, halat ve kaldırma ekipmanları... KWB, PEWAG, TERRIER, OX, ROPEBLOCK, POWERK gibi dünyanın önde gelen markalı ürünleriyle müşterilerine hizmet vermektedir.

ERK SERVICE; Çelik Halat konusundaki tecrübelerini, uluslararası akredite sertifikalarla (TÜRKAK) birleştirmiş; uluslararası standartlara uygun halat muayenesi, bakımı, yağlaması, montajı ve doğru halat kullanımı konularında hizmet ve eğitim vermektedir.

ERK SAFETY; İş sağlığı ve güvenliği sektöründe, UVEX, DRAGER, UPOWER, POWERK, ACTIVEHAND ve diğer birçok değerli dünya markaları ile müşterilerine hizmet sunmaktadır.

Çalışma şeklimizle fark yaratıyoruz!

Erk Çelik olarak kurulduğumuz ilk andan itibaren kaliteye verdiğimiz önem ve zoru başarma azmimiz sayesinde kısa sürede sektörümüzde tanınmış olup; değişmez prensiplerimiz kalite, hizmet, uygun fiyat ve zamanında teslim olmuştur.

Gösterdiğiniz yakın ilgi ve desteğinizden ötürü teşekkür ederek sizlere bugün ve gelecekte hizmet vermekten mutluluk duyacağımızı söylemek isteriz.

ERK ÇELİK HALAT SANAYİ VE TİCARET ANONİM ŞİRKETİ

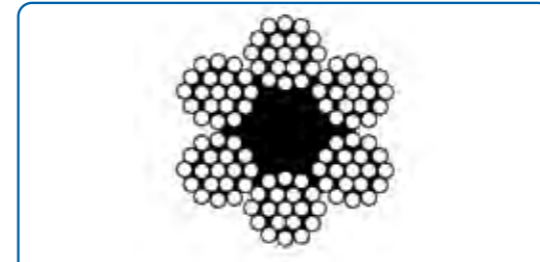

6x19 + K.ÖZ					\$ / MT	
MM	Kg/m	m.k.y. Kg	Siyah	Galvaniz		
6	0,131	1990	1,075	1,238		
8	0,233	3540	1,925	2,125		
10	0,364	5983	2,625	3,000		
12	0,498	8550	3,688	4,100		
14	0,678	11650	4,675	5,225		
16	0,886	15400	5,975	6,875		
18	1,120	17500	7,575	8,625		
20	1,244	24500	9,000	10,00		

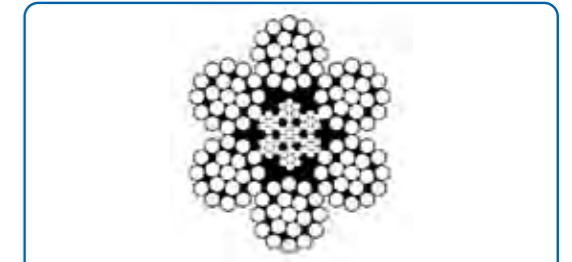

6x19 + Ç.ÖZ					\$ / MT	
MM	Kg/m	m.k.y. Kg	Siyah	Galvaniz		
6	0,145	2300	1,188	1,375		
8	0,244	4104	2,125	2,438		
10	0,381	6413	2,913	3,363		
12	0,549	9200	4,100	4,725		
14	0,747	12600	5,225	6,050		
16	0,975	16400	6,625	7,625		
18	1,234	19300	8,375	9,625		
20	1,610	23240	10,00	11,50		

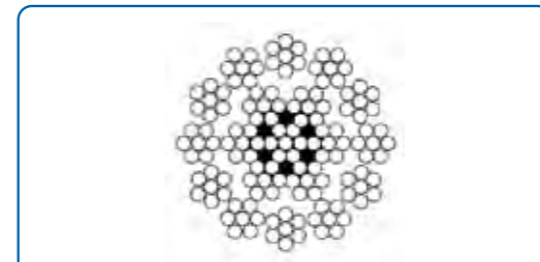

19x7 NUFLEX DÖNMEZ HALAT					\$ / MT	
MM	Kg/m	m.k.y. Kg	Siyah	Galvaniz		
4	0,056	1240	0,968	1,064		
5	0,088	1780	1,419	1,559		
6	0,125	1998	1,795	1,967		
8	0,230	3520	2,924	3,220		
10	0,340	5520	4,260	4,686		
12	0,500	4960	5,779	6,358		
14	0,680	10800	7,820	8,601		
16	0,890	14200	10,213	11,234		
18	1,280	21200	12,900	14,190		
20	1,670	26200	16,018	17,619		

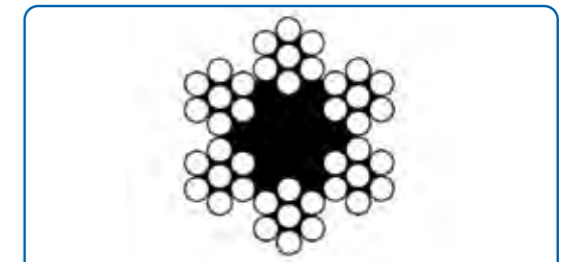

6x7 K.ÖZ					\$ / MT	
MM	Kg/m	m.k.y. Kg	Siyah	Galvaniz		
2	0,014	248		0,220		
3	0,032	528		0,331		
4	0,056	940		0,583		
5	0,088	1460		0,871		

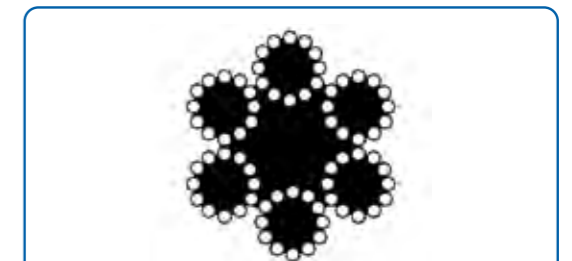

6x12 + 7 K.ÖZ					\$ / MT	
MM	Kg/m	m.k.y. Kg	Siyah	Galvaniz		
6	0,087	1270	0,713	0,813		
8	0,156	2290	1,200	1,375		
10	0,250	3670	1,775	2,025		
12	0,355	5210	2,550	2,925		
14	0,48	7130	3,375	3,875		
16	0,54	9340	4,425	5,075		



7x7 Ç.ÖZ			\$/ MT
MM	Kg/m	m.k.y. Kg	Galvaniz
1,5	0,013	175	0,210
2	0,020	360	0,242
3	0,039	598	0,400
4	0,066	1160	0,638
5	0,106	1670	1,012
6	0,138	1997	1,484

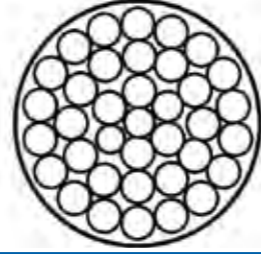

ŞEFFAF İZOLELİ ÇELİK HALATLAR				\$/ MT
MM	Kg/m	m.k.y. Kg		Galvaniz
2-3	0,042	290		0,330
3-4	0,057	550		0,490
4-5,5	0,070	710		1,000
4-6	0,098	940		1,010
5-7	0,127	1160		1,420
6-8	0,155	1360		1,420
8-10	0,185	1620		2,150
10-12	0,295	1450		3,050
12-14	0,470	3680		3,960



8X19 S K.ÖZ ASANSÖR HALATI		\$/ MT
MM		Siyah
8		2,530
10		2,860
11		3,575
12		4,070

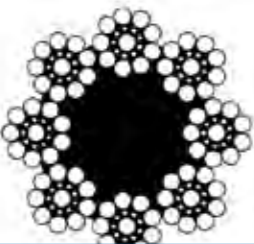

8X19 S Ç.ÖZ ASANSÖR HALATI		\$/ MT
MM		Siyah
6,5		3,080
8		2,860
10		3,232
11		4,040
12		4,600

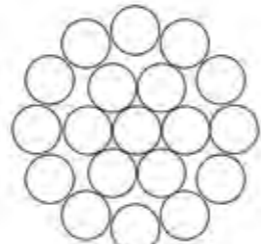

1X19 MONOTRON HALAT			\$/ MT
MM	Kg/m		Galvaniz
1	0,010		0,138
1,5	0,015		0,171
2	0,020		0,308
3	0,045		0,694
4	0,078		1,243
6			2,780

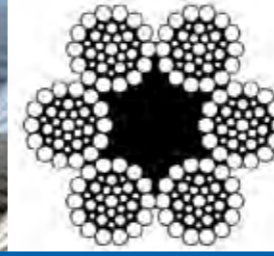

6x36 WS + K.ÖZ					€/ MT
MM	Kg/m	m.k.y. Kg	Siyah		Galvaniz
8	0,256	4867	2,16		2,49
10	0,367	6450	3,02		3,47
12	0,528	8550	3,71		4,27
13	0,623	10075	4,38		5,04
14	0,719	11600	4,85		5,58
16	0,940	15200	5,82		6,69
18	1,189	19200	7,22		8,38
19	1,328	21500	7,87		9,05
20	1,468	23800	8,73		10,11
22	1,776	28700	10,13		11,64
24	2,114	34200	12,03		14,14
26	2,481	40100	13,90		15,95
28	2,877	46600	15,52		17,46
30	3,303	53700	17,78		20,04
32	3,758	60800	20,26		22,80
34	4,243	71713	22,95		25,75
36	4,756	77000	25,43		28,88
38	5,300	85000	28,66		31,90
40	5,872	95000	31,79		35,67
42	6,474	104700	35,02		39,33
44	7,105	115000	38,36		43,10
46	7,766	127600	41,38		46,34
48	8,456	136800	45,04		50,43
50	9,175	146700	48,81		54,74
52	9,924	158000	52,26		58,51
56	11,509	183200	60,56		69,64
58	12,346	196500	64,66		72,20
60	13,212	210300	68,97		77,59
62	14,300	226400	73,28		82,97
64	14,530	240000	78,66		88,36
66	15,140	257400	83,51		92,67
68	16,220	272300	88,36		99,14
70	18,310	291600	92,67		104,53

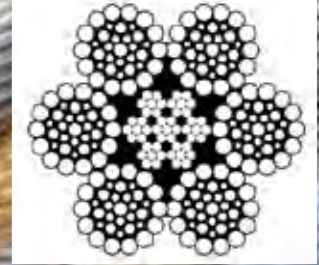

6x36 WS + Ç.ÖZ					€/ MT
MM	Kg/m	m.k.y. Kg	Siyah		Galvaniz
8	0,284	5275	2,41		2,77
10	0,409	6980	3,34		3,84
12	0,589	9240	4,14		4,76
13	0,695	10920	4,85		5,58
14	0,802	12600	5,39		6,25
16	1,047	16400	6,57		7,54
18	1,325	20800	8,19		9,38
19	1,480	23200	9,05		10,45
20	1,636	25600	10,13		11,64
22	1,980	31000	11,42		13,15
24	2,356	36900	13,58		15,62
26	2,765	43300	15,66		18,10
28	3,207	50300	17,56		20,20
30	3,685	58000	20,03		22,53
32	4,188	65800	22,79		25,64
34	4,728	74900	25,73		28,95
36	5,301	83200	28,85		32,45
38	5,906	92700	32,15		36,16
40	6,544	103000	35,61		40,06
42	7,214	117400	39,25		44,16
44	7,918	124000	43,08		48,46
46	8,654	136300	46,88		52,59
48	9,423	147600	51,08		57,22
50	10,225	154750	55,39		61,96
52	11,059	160680	59,91		66,81
56	11,800	186400	68,97		77,25
58	12,760	202427	73,81		82,65
60	13,688	214027	78,88		88,36
62	15,950	222100	84,05		94,29
64	16,210	233670	87,28		96,98
66	17,170	246400	94,18		105,48
68	18,000	260010	100,22		112,07
70	19,340	277600	105,60		118,53

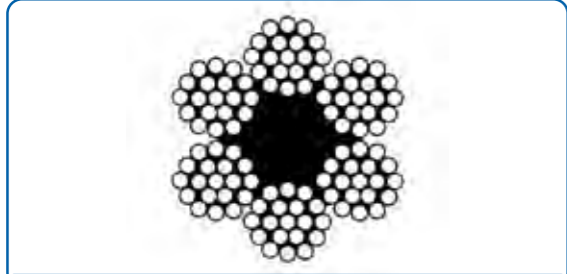

6x19 K.ÖZ					€/ MT	
MM	Kg/m	m.k.y. Kg	Siyah	Galvaniz		
8	0,243	3800	1,66	1,91		
10	0,380	5983	2,26	2,59		
12	0,548	8550	3,18	3,66		
14	0,745	11650	4,03	4,68		
16	0,973	15400	5,15	5,93		
18	1,235	19300	6,53	7,51		
20	1,521	23600	7,76	8,94		

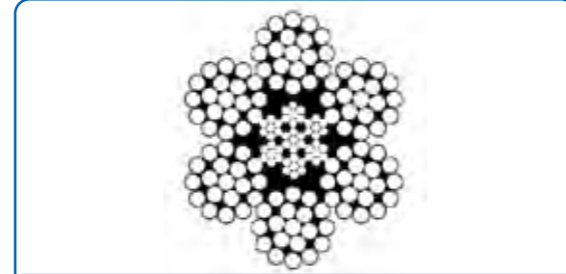

6x19 Ç.ÖZ					€/ MT	
MM	Kg/m	m.k.y. Kg	Siyah	Galvaniz		
8	0,268	4104	1,83	2,10		
10	0,418	6413	2,51	2,90		
12	0,605	9200	3,53	4,07		
14	0,820	12600	4,50	5,22		
16	1,070	16400	5,71	6,57		
18	1,350	20800	7,22	8,30		
20	1,680	25600	8,62	9,91		

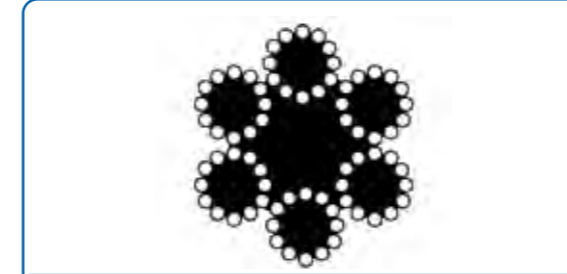

6x12 + 7 K.ÖZ					€/ MT	
MM	Kg/m	m.k.y. Kg	Siyah	Galvaniz		
6	0,087	1270	0,61	0,70		
8	0,156	2290	1,03	1,19		
10	0,250	3670	1,53	1,75		
12	0,355	5210	2,20	2,52		
14	0,48	7130	2,91	3,34		
16	0,624	9150	3,81	4,38		

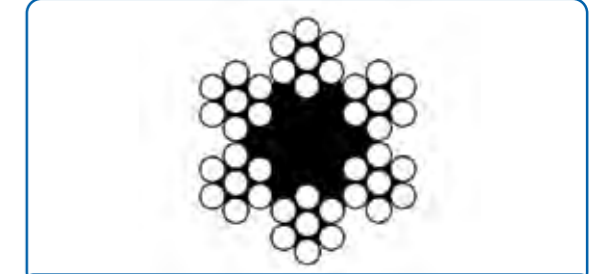

6X7 K.ÖZ					€/ MT	
MM	Kg/m		Siyah	Galvaniz		
5	0,086		0,66	0,78		
6	0,150		0,93	1,09		
8	0,229		1,52	1,79		
10	0,357		2,19	2,57		
12	0,519		3,16	3,71		
14	0,680		4,18	4,91		
16	0,880		5,39	6,33		

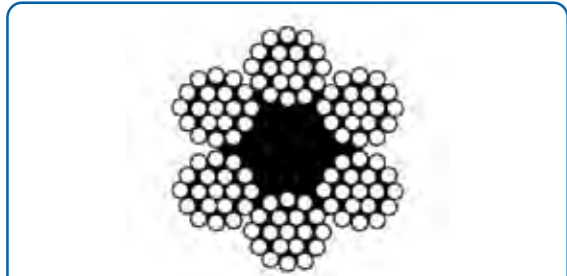

6X19 - 6X25 FILLER - SEALE - WARR. K.ÖZ					€/ MT	
MM	Kg/m	m.k.y. Kg	Siyah	Galvaniz		
8	0,243	3800	1,87	2,20		
10	0,380	5983	2,48	2,92		
12	0,548	8550	3,42	4,02		
14	0,745	11650	4,36	5,12		
16	0,973	15400	5,53	6,50		
18	1,235	19300	6,90	8,11		
20	1,521	23600	8,52	10,02		
22	1,850	28750	10,31	12,12		
24	2,200	34200	12,27	14,42		
26	2,600	40150	14,28	16,78		
28	2,980	46580	16,47	18,53		
30	3,430	53520	18,53	20,84		
32	3,897	60837	21,02	23,64		
34	4,15	74800	23,73	26,69		
36	4,933	77,020	26,60	29,93		
38	5,184	93400	29,64	33,35		

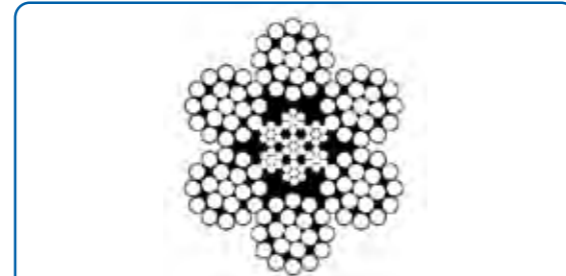

6X19 - 6X25 FILLER - SEALE - WARR. Ç.ÖZ					€/ MT	
MM	Kg/m	m.k.y. Kg	Siyah	Galvaniz		
8	0,268	4104	2,08	2,44		
10	0,418	6413	2,77	3,25		
12	0,605	9200	3,81	4,47		
14	0,820	12600	4,86	5,71		
16	1,070	16400	6,16	7,24		
18	1,350	20800	7,69	9,04		
20	1,680	25600	9,49	11,16		
22	2,200	31200	11,49	13,50		
24	2,410	37350	13,67	16,07		
26	2,630	43400	15,91	18,69		
28	3,280	50420	18,35	20,64		
30	3,768	57800	20,64	23,22		
32	4,290	65750	23,42	26,35		
34	4,624	80,700	26,43	29,74		
36	5,430	83,240	29,64	33,35		
38	5,776	100,800	33,02	37,15		

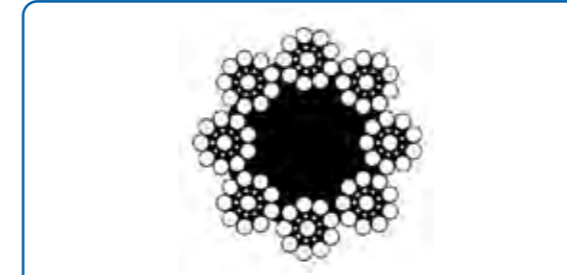

8X19 SEALE ASANSÖR HALATI K.ÖZ					€/ MT	
MM	Kg/m	m.k.y. Kg	Siyah	Galvaniz		
8	0,232	3650	2,26	2,65		
10	0,348	5170	2,70	3,17		
12	0,502	7440	3,85	4,52		
14	0,670	11400	5,10	5,99		

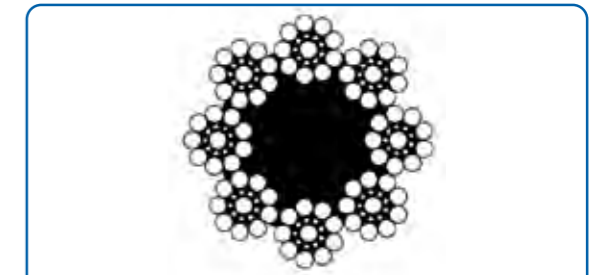

8X19 SEALE ASANSÖR HALATI Ç.ÖZ					€/ MT	
MM	Kg/m	m.k.y. Kg	Siyah	Galvaniz		
8			2,69	3,16		
10			3,24	3,81		
12			4,59	5,39		
14			6,26	7,36		

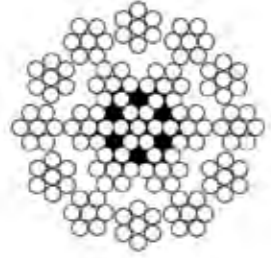

18X7				€/MT
MM	Kg/m	m.k.y. Kg		Ç.Ö.
8	0,254	4600		2,58
10	0,402	5910		3,56
12	0,579	8500		4,85
14	0,788	11600		6,25
16	1,030	15100		7,76
18	1,300	19100		9,59
19	1,450	21350		10,67
20	1,600	23600		11,42
22	1,945	30900		13,90
24	2,315	34000		16,27
26	2,717	39900		18,97
28	3,151	46300		21,55
32	4,116	70246		28,02
34	5,375	106563		31,25

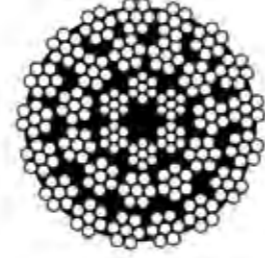

35X7 NUFLEKS				€/MT
MM	Kg/m	m.k.y. Kg		Ç.Ö.
16	1,150	16300		9,81
18	1,300	22230		12,50
19	1,450	24815		14,01
20	1,600	27400		15,09
22	1,950	33200		18,32
24	2,320	39500		21,88
26	2,717	46300		24,89
28	3,150	53700		28,88
30	3,630	62440		31,90
32	4,116	70246		36,10
34	4,636	72120		40,73
36	5,197	80800		44,72
40	6,146	95700		55,50
44	7,763	12070		67,67
48	9,239	14360		87,28
52	10,843	152700		91,59

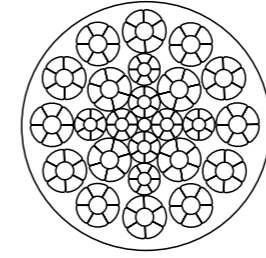

H24LRK (24X7 CMPCT)					€/MT
MM	Kg/m	m.k.y. Kg	Siyah	Galvaniz	
9	0,350	6960	4,54	5,33	
10	0,460	8800	5,84	6,86	
11	0,560	10800	6,73	7,91	
12	0,670	12900	7,16	8,41	
13	0,780	15000	8,31	9,76	
14	0,910	17600	9,38	11,02	
16	1,200	23200	12,06	14,17	
18	1,510	29200	14,70	17,28	
19	1,690	32500	16,04	18,85	
20	1,880	36000	17,95	21,09	
22	2,280	43000	21,50	25,26	
24	2,740	52000	25,65	30,14	
25,4	3,040	57600	28,66	33,68	

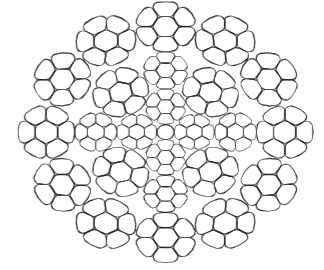

H 8K PI (8X26 PLASTİK DOLGU) Ç.ÖZ					€/MT
MM	Kg/m	1960 mbl kN	Siyah	Galvaniz	
14	0,90	177	10,24	12,03	
16	1,15	220	12,53	14,72	
18	1,48	283	15,83	18,60	
19	1,63	312	17,32	20,35	
20	1,84	352	18,88	22,18	
22	2,17	416	22,66	26,62	
24	2,55	507	26,82	31,52	
25,40	2,88	554	30,21	35,49	
26	3,05	585	31,68	37,23	
28	3,55	682	36,66	42,16	
30	4,13	790	42,30	36,71	
32	4,70	900	46,53	48,63	
34	5,26	1,012	52,37	60,23	
36	5,97	1,142	58,96	67,80	
38	6,61	1,190	65,52	75,35	
40	7,30	1,402	72,05	82,86	
44	9,00	1,726	88,83	102,16	
46	9,78	1,874	96,53	111,01	
48	10,66	2,045	105,22	121,00	
50	11,70	2,240	115,49	132,81	
52	12,60	2,413	124,37	143,02	

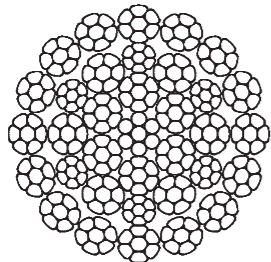

H35 NRK PI (35X7 CMPCT PLST.DOLGU)					€/MT
MM	Kg/m	1960 mbl kN	Siyah	Galvaniz	
16	1,23	223	17,79	20,91	
18	1,58	282	22,32	26,23	
20	2,01	357	28,18	33,12	
22	2,41	430	33,68	39,58	
24	2,84	505	39,88	46,86	
26	3,35	598	47,21	55,47	
28	3,91	696	54,69	62,90	
30	4,46	794	62,25	71,60	
32	5,03	896	69,11	79,47	
34	5,74	1023	77,68	89,34	
36	6,42	1142	86,69	99,69	
38	7,18	1279	97,80	112,47	
40	7,93	1412	110,04	126,54	
42	8,70	1549	120,58	138,67	

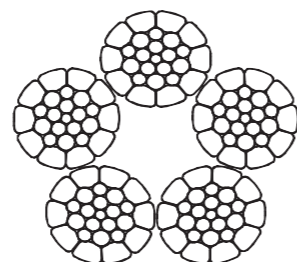

5XK19W PO ÖZ				€/MT
MM	2160 MBL kN	Siyah	Galvaniz	
8,3	54,30	2,74	3,22	
9	66,90	3,33	3,91	
9,5	69,10	3,51	4,13	
10,3	82,00	3,78	4,44	

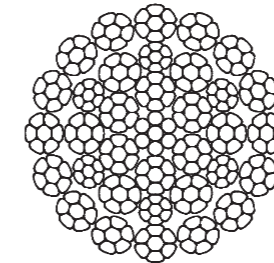

H35 NRC (35X7)					€/MT
MM	Kg/m	1960 mbl kN	Siyah	Galvaniz	
16	1,23	223	11,56	13,58	
18	1,56	282	14,47	17,00	
20	2,01	357	17,99	21,15	
22	2,41	430	21,32	25,05	
24	2,84	505	25,31	29,74	
26	3,35	598	29,71	34,90	
28	3,91	696	34,03	39,13	
30	4,46	794	38,40	44,13	
34	5,74	1023	48,28	55,53	
38	7,18	1279	61,25	70,44	
48			95,54	109,87	
50			104,71	120,42	

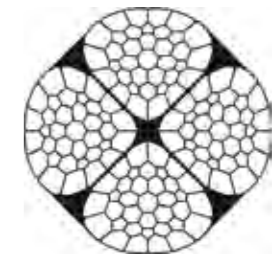

4x39 SES GALV. K.ÖZ		€/MT
MM	Galvaniz	
28		26,00
32		32,94
33,5		34,78
36		40,29

UYGULAMA ALANLARI APPLICATION



KALİTE QUALITY

EN10138-3, ASTM A416/A 416M, TS5680



PAKET ÖLÇÜLERİ COIL SIZE

Ağırlık / Weight
2500 - 4000 (kg)

MEKANİK ÖZELLİKLER MECHANICAL PROPERTIES

MEKANİK ÖZELLİKLER											1000 SAAT SONUNDA MAX. GEVŞEME		
MECHANICAL PROPERTIES											MAX. RELAXATION		
ÇAP NOMINAL DIAMETER	KOPMA MUKAVEMETİ BREAKING STRENGTH	KESİT ALANI STEEL AREA OF STRAND	BİRİM AĞIRLIK WEIGHT OF STRAND		BAŞLANGIÇ YÜKÜ INITIAL LOAD	%1'LİK UZAMADAKİ MİNİMUM YÜK MINIMUM LOAD AT 1.0%EXTENSION		70% of BL	80% of BL				
			in	mm		ibf	kN			ibf	kN	%	%
Grade 250 (1725)													
0,250	6,35	9000	40	0,036	23	122	182	900	4	8100	36	2,5	3,5
0,313	7,95	14500	64,5	0,058	37	197	294	1450	6,5	13050	58,1	2,5	3,5
0,375	9,53	20000	89	0,08	52	272	405	2000	8,9	18000	80,1	2,5	3,5
0,438	11,13	27000	120	0,108	69,7	367	548	2700	12	24300	108,1	2,5	3,5
0,5	12,70	36000	160	0,144	92,9	490	730	3600	16	32400	144,1	2,5	3,5
0,6	15,24	54000	240	0,216	139	737	1090	5400	24	48600	216,2	2,5	3,5
Grade 270 (1860)													
0,375	9,53	23000	102	0,085	55	290	430	2300	10,2	20700	92,1	2,5	3,5
0,438	11,13	31000	138	0,115	74,2	390	580	3100	13,8	27900	124,1	2,5	3,5
0,5	12,7	41300	184	0,153	98,7	520	780	4130	18,4	37170	165,3	2,5	3,5
0,52	13,2	45000	200	0,167	108	570	840	4500	20	40500	180,1	2,5	3,5
0,563	14,3	51700	230	0,192	124	650	970	5170	23	46530	207	2,5	3,5
0,6	15,24	58600	261	0,217	140	740	1100	5860	26,1	52740	234,6	2,5	3,5
0,62	15,75	62800	279	0,231	150	780	1200	6280	27,9	56520	251,4	2,5	3,5
0,7	17,78	79400	353	0,294	190	1000	1500	7940	35,3	71500	318	2,5	3,5

FIYAT BİLGİSİ İÇİN MÜŞTERİ TEMSİLCİMİZ İLE İRTİBATA GEÇİNİZ

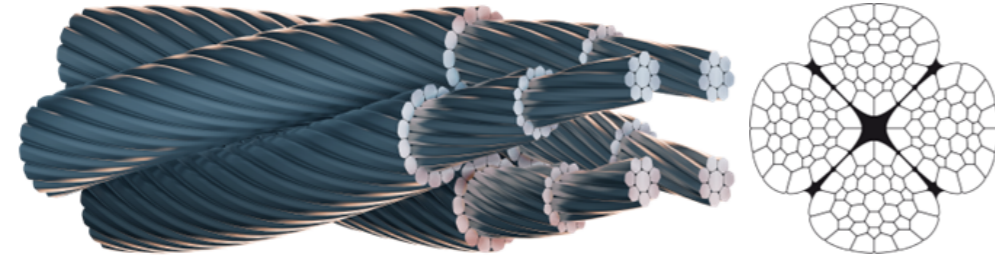

VERO 4

Sıkıştırılmış telleri bulunan 4 kollu dönmeye dirençli halat.

Halat Türü: Hoist Halatı

Uygulamalar: Gemi Vinci
STS Konteyner Vinç

- ✓ Yüksek kopma mukavemetlidir
- ✓ Çok sağlam halat yapısındadır
- ✓ Ezilmeye ve aşınmaya karşı kusursuz dayanım gösterir

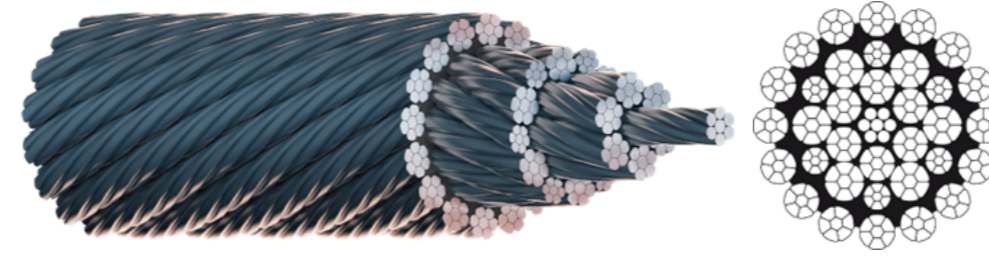

VEROTOP

verotop sıkıştırılmış telleri bulunan çok esnek, dönmeye dirençli bir halattır.

Halat Türü: Hoist Halatı Yardımcı Hoist Halatı Kelly Halatı

Uygulamalar: Gemi Vinci Zemin Ekipmanı
Açık Deniz Vinci STS Konteyner Vinç

- ✓ Çok yüksek kopma mukavemetlidir
- ✓ Çok iyi eğilme yorulması sonuçlarına ulaşır
- ✓ Ezilmeye ve aşınmaya karşı kusursuz dayanım gösterir
- ✓ Çok katmanlı tambura mükemmel sarım özelliğine sahiptir
- ✓ Fırdöndü ile veya fırdöndü olmadan kullanılabilir
- ✓ ASTM A1023 standart şartnamesine göre kategori 1 dönmeye dirençli halattır

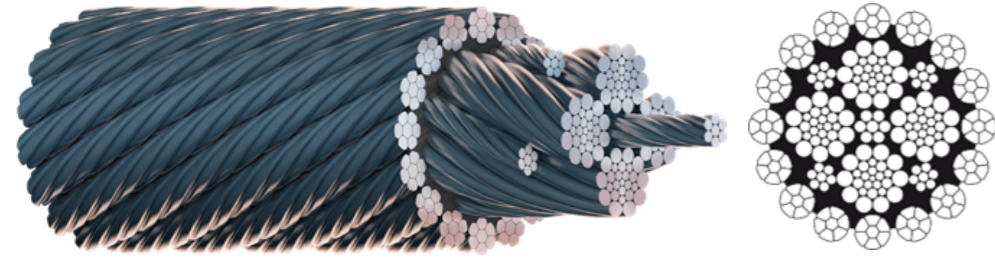

VEROTOP E

verotop E sıkıştırılmış dış telleri bulunan dönmeye dirençli bir halattır.

Halat Türü: Hoist Halatı Yardımcı Hoist Halatı

Uygulamalar: Pergel Vinç Orsa Vinç
Tavan Vinci Kule Vinç
Kamyonlu Vinç

- ✓ Yüksek kopma mukavemetlidir
- ✓ Çok iyi eğilme yorulması sonuçlarına ulaşır
- ✓ Ezilmeye ve aşınmaya karşı mükemmel dayanım gösterir
- ✓ Çok katmanlı tambura mükemmel sarım özelliğine sahiptir
- ✓ Fırdöndü ile veya fırdöndü olmadan kullanılabilir
- ✓ ASTM A1023 standart şartnamesine göre kategori 1 dönmeye dirençli halattır

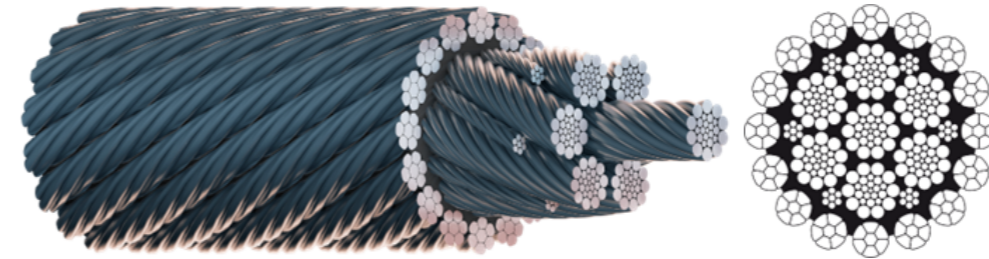

VEROTOP S

verotop S sıkıştırılmış dış telleri ve çok yüksek kopma mukavemeti bulunan çok esnek dönmeye dirençli bir halattır.

Halat Türü: Hoist Halatı Yardımcı Hoist Halatı

Uygulamalar: Paletli Vinç Mobil Vinç

- ✓ Çok güçlü, sıkıştırılmış ve dönmeye dirençli bir halattır
- ✓ Çok iyi eğilme yorulması sonuçlarına ulaşır
- ✓ Ezilmeye ve aşınmaya karşı kusursuz dayanım gösterir
- ✓ Çok katmanlı tambura mükemmel sarım özelliğine sahiptir
- ✓ Fırdöndü ile veya fırdöndü olmadan kullanılabilir
- ✓ ASTM A1023 standart şartnamesine göre kategori 1 dönmeye dirençli halattır

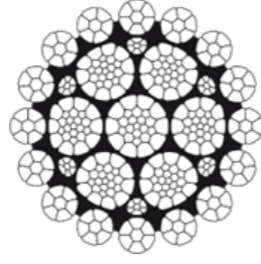

VEROTOP S+

verotop S+ sıkıştırılmış dış telleri ve olağanüstü derecede yüksek kopma mukavemeti bulunan çok esnek dönmeye dirençli bir halattır.

Halat Türü: Hoist Halatı Yardımcı Hoist Halatı

Uygulamalar: Paletli Vinç Mobil Vinç

- ✓ Tüm sıkıştırılmış dönmeye dirençli halatların en güçlüsüdür
- ✓ Çok iyi eğilme yorulması sonuçlarına ulaşır
- ✓ Ezilmeye ve aşınmaya karşı kusursuz dayanım gösterir
- ✓ Çok katmanlı tambura mükemmel sarım özelliğine sahiptir
- ✓ Fırdöndü ile veya fırdöndü olmadan kullanılabilir
- ✓ ASTM A1023 standart şartnamesine göre kategori 1 dönmeye dirençli halattır

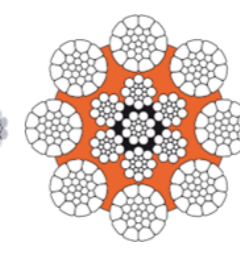
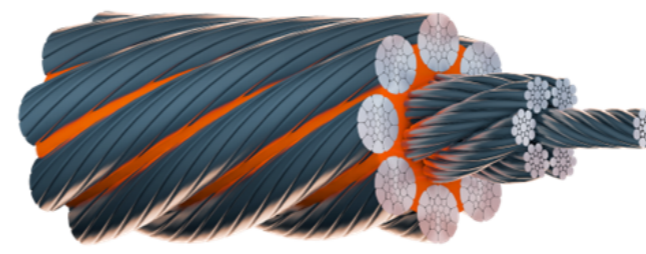

VEROPRO 8

veropro 8 sıkıştırılmış dış telleri ve plastik bir tabaka ile kaplı bir halat özü bulunan 8 kollu, dönmeye dirençsiz bir halattır.

Halat Türü: Boom Hoist Halatı Yardımcı Hoist Halatı
İtme Vinç Halatı Kapma Halatı Hoist Halatı
Orsa Vinç Halatı Asma Halatı

Uygulamalar: Paletli Vinç Gemi Vinci Pergel Vinç
Zemin Ekipmanı Pota Vinci Orsa Vinç
Ayaklı Köprülü Vinç (STS) Açık Deniz Vinci Mobil Vinç
Mobil Liman Vinci Tavan Vinci Kule Vinç
Liman İstif Taşıyıcısı STS Konteyner Vinç RTG Vinci

- ✓ Çok yüksek kopma mukavemetlidir
- ✓ Çok sağlam bir halat yapısına sahiptir ve mükemmel bükülme yorulması sonuçlarına ulaşır
- ✓ Çok sağlam bir halat yapısına sahiptir ve ezilmeye ve aşınmaya karşı kusursuz dayanıma ulaşır
- ✓ Çok katmanlı tambura mükemmel sarım özelliğine sahiptir

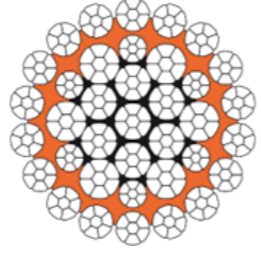
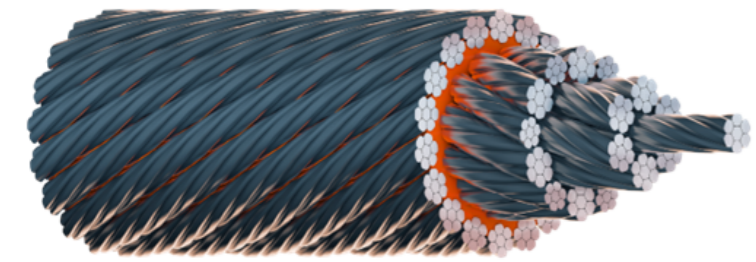

VEROTOP P

verotop P sıkıştırılmış telleri ve plastik bir tabaka ile kaplı bir halat özü bulunan dönmeye dirençli bir halattır.

Halat Türü: Hoist Halatı Yardımcı Hoist Halatı Kelly Halatı

Uygulamalar: Gemi Vinci Zemin Ekipmanı

Açık Deniz Vinci STS Konteyner Vinç

- ✓ Çok yüksek kopma mukavemetlidir
- ✓ Çok sağlam bir halat yapısı sunar ve mükemmel bükülme yorulması sonuçlarına ulaşır
- ✓ Kusursuz ezilme ve çok iyi aşınma aralığı sunar
- ✓ Çok katmanlı tambura mükemmel sarım özelliğine sahiptir
- ✓ Fırdöndü ile veya fırdöndü olmadan kullanılabilir
- ✓ ASTM A1023 standart şartnamesine göre kategori 1 dönmeye dirençli halattır

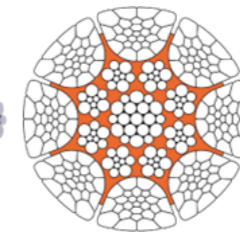
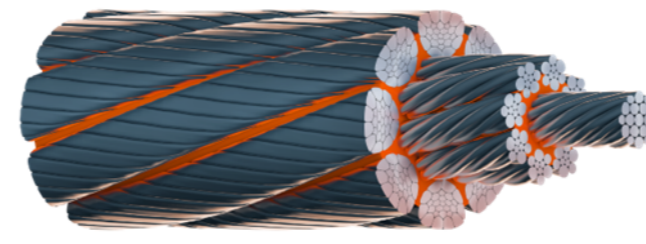

VEROPOWER 8

veropower 8 çift paralel tasarımda esnek bir çelik-plastik kombinasyonu bulunan 8 kollu, dönmeye dirençsiz bir halattır. Telleri sıkıştırılmış ve halat çekiçle dövülmüştür.

Halat Türü: Yardımcı Hoist Halatı Boom Hoist Halatı
İtme Vinci Halatı Kapma Halatı Hoist Halatı
Orsa Vinç Halatı Asma Halatı Trolley Halatı

Uygulamalar: Paletli Vinç Gemi Vinci Pergel Vinç
Zemin Ekipmanı Pota Vinci Orsa Vinç
Ayaklı Köprülü Vinç (STS) Açık Deniz Vinci Mobil Vinç
Mobil Liman Vinci Tavan Vinci Kule Vinç
STS Konteyner Vinç

- ✓ Tüm dönmeye dirençsiz halatların en güçlüsüdür
- ✓ Çok sağlam bir halat yapısı sunar ve mükemmel bükülme yorulması sonuçlarına ulaşır
- ✓ Ezilmeye karşı üstün dayanım ve aşınmaya karşı kusursuz dayanım gösterir
- ✓ Çok katmanlı tambura mükemmel sarım özelliğine sahiptir

BIOGEN WIRESHIELD

Dünyada çıkan en son teknoloji ile üretilmiş yüksek performanslı, Ecolable sertifikalı, Biodegradable (doğada tamamen çözünen ve toksik atık bırakmayan) Amerikan VGP ve Avrupa EU Ecolabel standartlarına uyumlu ,yeşil liman projeleri için uygun çevreci halat yağı.Çevreci yapısıyla birlikte zor şartlarda kullanılan tüm halatlar için maksimum koruma değerlerine sahiptir.Doğada suyla temas eden her çeşit halatta limanlarda, tersanelerde ,gemilerde ve ROV denizaltı sistemlerinde uygulanabilir. Psödoplastik Reoloji (yük ve çalışma esnasında sıvı yağ formatında olup durma ve beklemelerde gres form alması) teknolojisi ile üretilmiştir.Bu teknoloji çalışma esnasında maksimum yağlama durma esnasında maksimum koruma sağlar.Ayrıca sarsıntılar ve çarpmalar ile damlama ve bulaşma riskini ortadan kaldırır.

WIRESHIELD

Psödoplastik Reoloji (yük ve çalışma esnasında sıvı yağ formatında olup durma ve beklemelerde gres form alması) teknolojisi ve şeffaf renk yapısı ile temiz yapışkan olmayan toz ve kir tutmayan üstün korozyon koruması ve su direnci ile temiz uygulamalar için kullanılan halat yağı.

WIRE ROPE SPREY

Suya toza kuma dayanıklı nüfuz edici yarı akışkan MoS2 katkılı halat sprey formatıdır.

WIRE ROPE DRESSING

Suya, toza, kuma dayanıklı, hızlı nüfuz eden, yarı akışkan halat gresidir. İhtiva etmiş olduğu MoS2 halatın özüne hızlı nüfuz ederek; mükemmel yağlayıcılığıyla yağlama periyodunu uzatır. 1 kg'su ile; 20 mm çapındaki halatın, 50 metresi yağlanır.

TUFGEAR UNIVERSAL

Toza ve yüke dayanıklı, aşınmayı, korozyonu önleyen, su defedici, süper yastıklama yapan gres kıvamında açık dişli yağdır. Yapışma özelliği içerdiğinden, bu maddeler yastıklama yapmak suretiyle aşınmayı azaltarak dişli ömrünü uzatır. Çalışma Sıcaklığı : -40°C ile +120°C'dir.

SAPPHIRE AQUA 2

Kalsiyum sabunu ile kalınlaştırılmış, su ile yıkamaya mükemmel direnci olan su gresidir. Deniz veya kirli suya maruz kalan ortamlarda istisnai bir korozyon korunması ve uzun yağlama periyodu sağlar. Çalışma Sıcaklığı: -30°C ile +150°C'dir. (NLGI 2)

SAPPHIRE HI TORQUE ISO VG 220cSt, 320cSt, 460cSt, 680cSt

Ağır yüke dayanıklı, aşınmaları azaltan,korozyonu ve köpürmeyi önleyen dişlileri koruyon uzun ömürlü yarı sentetik kapalı dişli yağdır. Üstün SUPS (start up) teknolojisi ile dur kalk larda mükemmel performans göstererek dişlilerde koruma sağlar.Sessiz titreşimsiz kullanım sağlar. Sürtünmeyi tüm noktalarda minimuma indirdiği için ısınmayı azaltır enerji tasarrufu sağlar. Çalışma sıcaklığı -20°C ile +120°C dir.

Ürün tanıtım video linki : <https://www.rocol.com/media/view/16/gear-oils-with-start-up-protection-system-sup>

CHAIN GUARD HI - LOAD SPREY

Konveyör hatlarına ve zincir tahrik sistemlerine tatbik edilen, ağır hizmet zincir yağlayıcı spreydir. MoS2 ihtiva eden, suya dayanıklı ve iyi yük taşıma kapasitesine sahip bir ince film tabakası oluşturur. Zor şartlarda ve ağır yük şartlarında çalışan zincir sistemlerinin yağlanması için kullanılır. Forklift zincirleri için idealdir. Çalışma sıcaklığı -30°C ile +180°C'dir.

MT-LM

MoS2 ihtiva edip ince film tabakası oluşturarak sıkışmayı mani olan montaj ve demontaj pastesi. Çalışma Sıcaklığı +450°C'dir.

ANTI-SEIZE COMPOUND

Somun civata ve saplamların kaynamasını önleyen bakır içerikli zehirsiz paste Çalışma Sıcaklığı : -10°C ile +1100°C'dir.

Performance You Can Trust



ÜRÜN KODU

20064
20069

PAKET ŞEKLİ

18 KG
160 KG

ÜRÜN KODU

20054
20058

PAKET ŞEKLİ

18 KG
160 KG

ÜRÜN KODU

20015

PAKET ŞEKLİ

400 ml

ÜRÜN KODU

20028
20029

PAKET ŞEKLİ

18 KG
160 KG

ÜRÜN KODU

18304

PAKET ŞEKLİ

18 KG

ÜRÜN KODU

12754

PAKET ŞEKLİ

18 KG

ÜRÜN KODU

220cSt - 21015
320cSt - 21025
460cSt - 21035
680cSt - 21045

PAKET ŞEKLİ

30 LT
30 LT
30 LT
30 LT

ÜRÜN KODU

22141

PAKET ŞEKLİ

300 ml

ÜRÜN KODU

10057

PAKET ŞEKLİ

1 KG

ÜRÜN KODU

14035

PAKET ŞEKLİ

6 KG



HAKKIMIZDA

ERK Group bünyesinde bulunan ERK Service, çelik halat konusundaki tecrübelerini gerekli eğitim ve sertifikalarla birleştirmiş olup, müşterilerine çelik halat ve ekipmanları konusunda destek vermek amacıyla kurulmuştur.

HİZMETLERİMİZ

- NDT SERVICE

Çelik halatların tahribatsız muayenesi İNTROS test cihazı ile uluslararası standartlara ve yönetmeliklere uygun olarak gerçekleştirilir.

Toplanan veriler, grafikler ve tablolar rapor haline getirilerek 10 iş günü içerisinde müşterilerimize sunulur. Test raporları kolay anlaşılabilir ve grafik desteklidir. Halattaki iç ve dış kopuk teller, halattaki kırıkların yerleri, tel kırık sayısı ve korozyon durumu raporda detaylı bir şekilde gösterilirken, değişim kriterlerine göre halatın kullanım durumu yorumlanır.



- HALATLARIN PERİYODİK KONTROLÜ

Halatların belirli periyotlarla gözle muayenesi ile kusurların belirlenmesi, halatın yağlama durumu, makara ve tambur sistemlerinin standartlara uygunluğu, standartlara uygun olarak ölçülerek rapor halinde müşteriye sunulur.

NOT : HİZMETLERİMİZ HAKKINDA DETAYLI BİLGİ ALMAK İÇİN LÜTFEN BİZİMLE İLETİŞİME GEÇİNİZ.

-HALAT DEĞİŞİMİ

Müşterilerimizin isteklerine bağlı olarak uzman kadromuz ile halat değişimini gerçekleştirilmekteyiz.

- HALATIN YAĞLANMASI

Halatların yağlanması, halatların kullanım ömürlerini arttırmada büyük role sahiptir. Müşterilerimizin isteklerine göre gerek cihaz tedariki gerek ise teknik destek ile hizmet vermekteyiz.

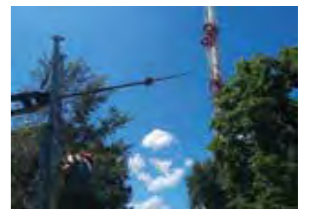



ÇELİK HALAT SAPAN RADANSALAR



RADANSA

MM	\$/AD
3	0,145
4	0,160
5	0,167
6	0,196
8	0,225
10	0,284
12	0,371
13	0,560
14	0,676
16	0,997
18	1,586
20	2,255
22	2,560
24	3,077
25-26	3,484
28	5,739
30	7,477
32	10,758
34	10,962
36	11,987
38	14,038
40	23,560
42	25,611
44	33,605
48	40,158



DOLU RADANSA

MM	\$/AD
10	6,990
12	11,943
16	19,792
18	26,542
20	35,118
22	44,974
24	56,590
26	73,283
28	81,233
30	110,000
32	126,360
34	155,000
36	180,447
38	210,000
40	241,336
44	326,315



ALÜMİNYUM - KURŞUN YÜZÜK

MM	\$/AD
1	0,048
1,5	0,054
2	0,068
2,5	0,075
3	0,088
4	0,116
5	0,170
6	0,190
8	0,374
10	0,673
12	1,149
14	1,917
16	3,739
18	5,397
20	7,341
22	9,857
24	12,712
26	15,974
28	19,985
30	27,286
32	31,609
34	39,750
36	46,950
38	57,800
40	65,700
42	78,300
44	88,950
46	105,200
48	116,800
52	150,200
56	189,100
60	228,500
64	280,000
68	325,000



ÇELİK HALAT PRES BASIM LİSTESİ

MM	\$/AD
6	3,20
8	3,55
10	4,80
12	8,00
14	8,80
16	10,00
18	15,90
20	20,00
22	23,00
24	30,00
26	39,00
28	44,00
30	65,00
32	76,00
34	82,00
36	92,00
38	110,00
40	130,00
44	180,00
48	240,00
52	300,00
56	380,00
60	450,00
64	580,00

ÇELİK HALAT SONLANDIRICILARI

HALAT SONLANDIRICI SAPLAMA + TEK UÇ PRES BASKI



6mm	23,00 USD
8mm	24,50 USD
10mm	26,50 USD
12mm	33,50 USD
14mm	55,50 USD
16mm	75,50 USD
18mm	91,00 USD
20mm	102,50 USD
22mm	133,50 USD
24mm	171,50 USD
26mm	189,00 USD
28mm	202,50 USD
30mm	233,50 USD
32mm	290,00 USD
36mm	340,00 USD

HALAT SONLANDIRICI ÇATAL + TEK UÇ PRES BASKI



6mm	38,00 USD
8mm	40,00 USD
10mm	42,50 USD
12mm	51,00 USD
14mm	75,50 USD
16mm	93,50 USD
18mm	102,50 USD
20mm	151,00 USD
22mm	190,00 USD
24mm	267,00 USD
26mm	310,00 USD
28mm	345,00 USD
30mm	467,00 USD
32mm	567,00 USD
36mm	620,00 USD

HALAT SONLANDIRICI GÖZ + TEK UÇ PRES BASKI



6mm	27,00 USD
8mm	29,00 USD
10mm	31,00 USD
12mm	40,00 USD
14mm	60,00 USD
16mm	83,00 USD
18mm	98,00 USD
20mm	112,00 USD
22mm	145,00 USD
24mm	187,00 USD
26mm	205,00 USD
28mm	223,00 USD
30mm	255,00 USD
32mm	312,00 USD
36mm	367,00 USD



A TİP KLEMENS

MM	Ad/Çuval	\$/AD
6	2000	0,163
8	1000	0,252
10	400	0,517
12	200	0,890
14	100	1,339
15	100	1,339
16	100	1,339
18	100	1,625
20	80	2,298
22	60	3,161
25	40	5,173
28	30	6,988
30	20	6,988
32	20	9,476
36	10	12,446
40	5	15,798
45	5	24,703
50	5	32,166



NORMAL ÇEKTİRME

MM	Ad/Çuval	\$/AD
6	500	0,575
8	500	0,913
10	250	1,210
12	200	2,506
14	100	3,385
16	100	4,881
20	60	8,633
22	40	12,161
25	40	15,764
28	20	30,882
30	20	31,950
32	10	38,604
36	10	51,120
38	10	67,446



DIN 741 KLEMENS

MM	Ad/Çuval	\$/AD
3	3000	0,088
4	3000	0,095
5	2500	0,109
6	2000	0,136
8	1000	0,204
10	500	0,378
12	250	0,706
16	150	1,106
19	100	1,331
20	100	1,331



DIN 1142 KLEMENS

MM	Ad/Çuval	\$/AD
6.5	2000	0,286
8	1000	0,557
10	500	0,585
13	250	1,625
16	150	2,583



HAMBURGER ÇEKTİRME

MM	Ad/Çuval	\$/AD
24	10	22,976
27x400	10	26,810



PİMLİ ÇEKTİRME

MM	Ad/Çuval	\$/AD
3/8"X6	40	9,726
1/2"X6	40	12,963
1/2"X9	20	15,126
1/2"X12	15	17,289
5/8"X9	10	22,689
5/8"X12	10	24,845
3/4"X9	10	32,408
3/4"X12	5	35,652
3/4"X18	5	43,216
7/8"X12	1	57,260
7/8"X18	1	66,979
1"X12	5	70,223
1"X18	1	83,187
1-1/4"X12	1	135,047
1-1/4"X18	1	162,055
1-1/4"X24	1	199,863
1-1/2"X12	1	199,863
1-1/2"X18	1	226,870
1-1/2"X24	1	264,686
1-3/4"X24	1	464,548
2-1/2"X24	1	1.620,531



BORULU TİP GERDİRME

MM	Tonaj	\$/AD
12X125	0,7	14,133
16X170	1,2	20,400
20X200	2	31,740
22X220	2,2	39,680
24X225	3,5	56,680
27X225	5	83,880
33X285	7	143,390



GALVANİZLİ KARABİNA

MM	Ad/Çuval	\$/AD
4	2000	0,299
5	1250	0,306
6	1000	0,347
7	500	0,476
8	400	0,564
9	250	0,795
10	200	0,890
11	120	1,244
12	100	1,917
13	100	3,256
14	100	5,221



ZİNCİR KANCASI

MM	\$/AD
1/4	3,351
5/16	4,595
3/8	5,554
1/2	12,256

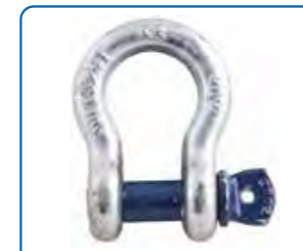

G 209 OMG TONAJLI Z.K. 6 WILL

MM	Tonaj	\$/AD
5/8"	3,25	7,465
7/8"	6,50	16,246
1"	8,50	22,534
1-1/8"	9,50	31,643
1-1/4"	12,00	43,845
1-3/8"	13,50	60,499
1-1/2"	17,00	79,872



GALVANİZLİ VİDALI KARABİNA

MM	Ad/Çuval	\$/AD
4	1000	0,517
5	500	0,469
6	400	0,476
7	250	0,585
8	200	0,673
9	120	0,911
10	100	1,006
11	100	1,387
12	100	2,155
14	100	5,506

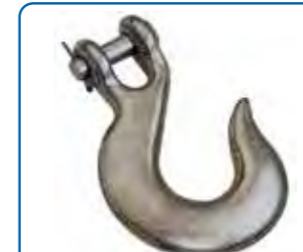

SAPAN KANCASI

MM	\$/AD
1/4	4,119
5/16	5,363
3/8	7,273
1/2	15,322
5/8	25,369



YÜK KALDIRMA KARABİNASI

MM	\$/AD
3,5	0,384
4	0,391
5	0,453
6	0,506
8	0,844
10	1,396
12	2,800



FIRDÖNDÜ

MM	\$/AD
1/4"	2,583
5/16"	2,971
3/8"	4,405
1/2"	8,840
5/8"	12,365
3/4"	19,383
7/8"	26,071
1"	47,691
1 1/2"	269,317
1 1/4"	93,209



YEDEK MANDAL

TON	\$/AD
0,5	0,306
1	0,490
1,5	0,510
2	0,580
3,2	0,552
4,5	0,587
5	0,740
6	0,750
7	0,973
8	0,950
10	1,250
11	1,397
15	3,280



DİŞİ AYBOLD		
MM	Ad/Çuval	\$/AD
6	400	0,916
8	400	0,916
10	200	1,305
12	125	1,953
14	100	1,981
16	75	3,157
18	50	3,194
20	50	4,462
22	50	4,564
24	25	8,869
27	12	9,258
30	12	16,302
36	12	28,689
42	8	44,982
48	4	74,319
56	2	104,314
64	2	149,944



G 210 TONAJLI Z.K. 4 WILL		
MM	Tonaj	\$/AD
1/4"	0,5	1,244
5/16"	0,75	1,577
3/8"	1,00	2,107
1/2"	2,00	3,351
5/8"	3,25	6,383
3/4"	4,75	9,734
7/8"	6,50	14,064
1"	8,50	19,258
1-1/8"	9,50	27,265
1-1/4"	12,00	36,782
1-3/8"	13,50	51,927
1-1/2"	17,00	65,455
1-3/4"	25,00	106,567
2"	35,00	159,038
2-1/2"	55,00	351,371
3"	80,00	574,449



G 209 TONAJLI Z.K. 4 WILL		
MM	Tonaj	\$/AD
1/4"	0,5	1,244
5/16"	0,75	1,625
3/8"	1,00	2,202
1/2"	2,00	3,446
5/8"	3,25	6,601
3/4"	4,75	9,952
7/8"	6,50	14,819
1"	8,50	20,339
1-1/8"	9,50	28,237
1-1/4"	12,00	39,052
1-3/8"	13,50	54,524
1-1/2"	17,00	70,974
1-3/4"	25,00	120,087
2"	35,00	180,131
2-1/2"	55,00	357,115
3"	85,00	649,128



A 342 SAPAN HALKASI		
MM	TON	\$/AD
13	2,20	6,325
16	3,00	11,828
19	4,70	14,810
20	4,70	14,810
22	6,40	19,336
25	11,00	28,387
32	16,00	51,836
42	21,70	89,891
44	28,40	148,443
48	44,30	220,238
58	65,00	369,005



TONAJLI FIRDÖNDÜLÜ KANCA		
TON	Ad/Çuval	\$/AD
1	200	7,851
1,5	200	9,571
2	100	13,881
3	50	15,798
4,5	30	21,703
5	30	30,637
7	20	59,357
11	10	89,994



TONAJLI KUŞGÖZ KANCA		
TON	Ad/Çuval	\$/AD
0,75	200	3,351
1	200	3,922
1,5	200	4,786
2	100	6,702
3	50	10,054
4,5	30	17,232
5	30	19,107
7	20	31,595
11	10	60,316
15	5	91,911



ERKEK AYBOLD		
MM	Ad/Çuval	\$/AD
6	400	0,916
8	400	0,916
10	200	1,305
12	125	1,889
14	100	1,926
16	75	2,999
18	50	3,064
20	50	4,305
22	50	4,305
24	25	8,609
27	12	9,128
30	12	15,817
32	12	27,000
36	8	28,689
42	4	44,982
45	2	76,930
48	1	76,930
52	1	110,831
56	1	120,831
64	1	156,461



G 2150 T. SOMUNLU GLV. ZİN. KİL.		
MM	Tonaj	\$/AD
5/16"	0.50T	1,822
3/8"	0,75T	2,345
7/16"	1,5 T	2,971
1/2"	2 T	4,215
5/8"	3,25 T	7,273
3/4"	4,75 T	10,720
7/8"	6,50 T	15,607
1"	8,50 T	21,447
1-1/8"	9,5 T	29,964
1-1/4"	12,00 T	41,167
1-3/8"	13,50 T	55,530
1-1/2"	17,00 T	70,852
1-3/4"	25,00 T	117,953
2"	35,00 T	170,417
2-1/2"	55 T	373,395
3"	85,00 T	552,431



G 2130 OMEGA T. S. GLV. ZİN. KİL.		
MM	Tonaj	\$/AD
5/16"	0,75 T	1,869
3/8"	1T	2,440
1/2"	2 T	4,310
5/8"	3,25 T	7,355
3/4"	4,75 T	11,033
7/8"	6,50 T	16,226
1"	8,50 T	22,398
1-1/8"	9,50 T	30,834
1-1/4"	12,00 T	43,056
1-3/8"	13,50 T	57,773
1-1/2"	17,00 T	75,950
1-3/4"	25,00 T	130,365
2"	35,00 T	191,490
2-1/2"	55,00 T	402,338
3"	85,00 T	670,194
3-1/2"	85,00 T	1.651,543



KOLLU GERDİRME		
MM	Ad/Çuval	\$/AD
1/4-5/16	10	38,891
5/16-3/8	10	53,613
3/8-1/2	10	81,381
1/2-5/8	10	100,050



CIRCIRLI GERDİRME		
MM	Ad/Çuval	\$/AD
1/4-5/16	10	49,786
5/16-3/8	10	62,232
3/8-1/2	10	66,060
1/2-5/8	5	81,381



OMEGA ZİNCİR KİLİDİ		
MM	Ad/Çuval	\$/AD
3/16"	2000	0,428
1/4"	2000	0,442
5/16"	1000	0,578
3/8"	500	0,911
1/2"	200	1,400
5/8"	100	3,073
3/4"	100	5,098
7/8"	80	8,048
1"	40	10,733
1-1/8"	30	16,770
1-1/4"	20	23,479



NORMAL ZİNCİR KİLİDİ		
MM	Ad/Çuval	\$/AD
1/4"	2000	0,415
5/16"	1000	0,544
3/8"	500	0,863
1/2"	200	1,271
14	100	1,869
5/8"	100	2,712
18	100	3,351
3/4"	100	4,697
7/8"	80	6,172
1"	40	10,394
1-1/8"	30	14,085
1-1/4"	20	21,127
1-1/2"	10	40,249
1-3/4"	10	65,529
2"	10	92,689



D RİNG	
WLL (Tons)	\$/AD
35	29,00



G 4151 GREEN PIN U TİPİ KİLİT

MM	Tonaj	€/AD
5	0,33 T	7,79
7	0,50 T	7,79
9	0,75 T	8,72
10	1,00 T	9,65
11	1,50 T	13,30
13,5	2,00 T	16,95
16	3,25 T	22,54
19	4,75 T	29,81
22	6,50 T	40,91
25	8,50 T	59,62
28	9,50 T	85,70
32	12,00 T	108,05
35	13,50 T	134,13
38	17,00 T	208,65
45	25,00 T	353,97
50	35,00 T	465,75
57	42,50 T	782,45
65	55,00 T	1.017,19



G 4161 GREEN PIN OMEGA TİP KİLİT

MM	Tonaj	€/AD
5	0,33 T	7,79
7	0,50 T	7,79
9	0,75 T	8,80
10	1,00 T	9,80
11	1,50 T	13,40
13,5	2,00 T	16,95
16	3,25 T	22,36
19	4,75 T	29,81
22	6,50 T	40,90
25	8,50 T	55,89
28	9,50 T	85,70
32	12,00 T	108,05
35	13,50 T	134,13
38	17,00 T	208,65
45	25,00 T	353,97
50	35,00 T	465,75
57	42,50 T	849,52
65	55,00 T	979,93



G 4163 GREEN PIN OMEGA SOM. TİP KİLİT

MM	Tonaj	€/AD
7	0,50 T	9,02
9	0,75 T	10,21
10	1,00 T	12,10
11	1,50 T	14,30
13,5	2,00 T	18,26
16	3,25 T	29,06
19	4,75 T	38,00
22	6,50 T	48,44
25	8,50 T	74,52
28	9,50 T	104,33
32	12,00 T	145,31
35	13,50 T	186,30
38	17,00 T	249,64
45	25,00 T	383,77
50	35,00 T	514,18
57	42,50 T	942,67
65	55,00 T	1.102,88
75	85,00 T	1.628,25



G 4153 GREEN PIN U TİPİ SOM. KİLİT

MM	Tonaj	€/AD
13,5	2,00 T	18,26
16	3,25 T	28,88
19	4,75 T	37,86
22	6,50 T	50,41
25	8,50 T	75,00
28	9,50 T	100,60
32	12,00 T	145,31
35	13,50 T	182,57
38	17,00 T	249,64
45	25,00 T	376,32
50	35,00 T	503,00
57	42,50 T	953,85
65	55,00 T	1.047,00
75	85,00 T	1.628,25



G 5263 SUPER GREEN PIN KİLİT

MM	Tonaj	€/AD
83	120 T	4.158,17
95	150 T	4.221,52



DIN 741 GREEN PIN KLEMENS

MM	€/AD
3	0,26
5	0,37
6,5	0,41
8	0,52
10	0,86
11	0,97
13	1,60
14	1,83
16	2,72
19	3,35
22	5,14
26	5,51
30	8,83
34	10,73
40	12,67



DIN 1142 GREEN PIN KLEMENS

MM	€/AD
5	0,37
6,5	0,41
8	0,63
10	0,86
12	1,52
13	1,85
14	2,15
16	2,80
19	3,35
22	5,14
26	8,35
30	11,15
34	15,07
40	23,16



DIN 1480 GREEN PIN ÇEKTİRME GÖZ + GÖZ

MM	€/AD
6	2,79
8	3,76
10	6,07
12	9,50
14	14,20
16	18,89
20	31,11
22	35,77
24	50,86
30	89,42



DIN 1480 GREEN PIN ÇEKTİRME KANCA + GÖZ

MM	€/AD
5	2,90
6	3,02
8	3,80
10	5,70
12	7,82
14	9,91
16	15,65
20	31,67
22	37,37
24	53,47
30	87,56



G 3161 YELLOW PIN OMEGA TİP KİLİT

MM	Tonaj	€/AD
5	0,33 T	2,68
6	0,50 T	3,24
8	0,75 T	3,50
10	1 T	5,59
11	1,50 T	6,07
13	2 T	7,23
16	3,25 T	13,56
19	4,75 T	20,87
22	6,50 T	30,74
25	8,50 T	39,31
28	9,50 T	59,62
32	12 T	85,70
35	14 T	108,05
38	17 T	155,19
45	25 T	272,00



G 3151 YELLOW PIN DÜZ TİP KİLİT

MM	Tonaj	€/AD
5	0,33 T	2,68
6	0,50 T	3,22
8	0,75 T	3,50
10	1 T	4,40
11	1,50 T	5,07
13	2 T	6,67
16	3,25 T	13,20
19	4,75 T	19,80
22	6,50 T	26,47
25	8,50 T	38,2
28	9,50 T	57,33
32	12 T	74,80
35	13,50 T	101,2
38	17 T	133,4
45	25 T	277,33



G 3163 YELLOW PIN OMEGA SOM. TİP KİLİT

MM	Tonaj	€/AD
13	2 T	8,73
16	3,25 T	14,67
19	4,75 T	21,27
22	6,50 T	30,80
25	8,50 T	45,40
28	9,50 T	69,67
32	12 T	97,53
35	13,50 T	133,40
38	17 T	163,67
45	25 T	344,00



G 3153 YELLOW PIN U TİP SOM. KİLİT

MM	Tonaj	€/AD
13	2 T	8,731
16	3,25 T	14,67
19	4,75 T	21,27
22	6,50 T	30,80
25	8,50 T	39,67
28	9,50 T	63,07
32	12 T	96,07
35	13,50 T	115,07
38	17 T	158,47
45	25 T	338,87

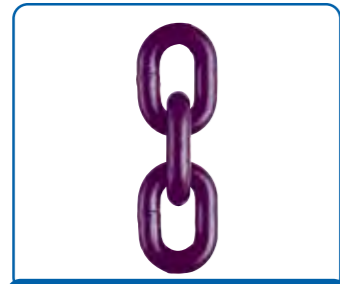

EN818-2 80 ZİNCİR

MM	WWL TON	\$/Mt.
6-8	1,4	Fiyat Sorunuz
8-8	2	Fiyat Sorunuz
10-8	3,15	Fiyat Sorunuz
13-8	5,3	Fiyat Sorunuz
16-8	8	Fiyat Sorunuz



GRADE 100 ZİNCİR

MM	WWL TON	\$/Mt.
6-8		Fiyat Sorunuz
8-8		Fiyat Sorunuz
10-8		Fiyat Sorunuz
13-8		Fiyat Sorunuz
16-8		Fiyat Sorunuz



GR - 80 ZİNCİR SAPAN YAPIMI İÇİN MALZEME SEÇİM TABLOSU



Z-1



Z-2



Z-12

$0^\circ < \beta \leq 45^\circ$

$45^\circ < \beta \leq 60^\circ$

$0^\circ < \beta \leq 45^\circ$

$45^\circ < \beta \leq 60^\circ$

Zincir	Tekli Sapan	Çiftli Sapan		4'lü Sapan	
mm	Kg	Kg	Kg	Kg	Kg
6	1120	1600	1120	2360	1700
7	1500	2120	1500	3150	2240
8	2000	2800	2000	4250	3000
10	3150	4250	3150	6700	4750
13	5300	7500	5300	11200	8000
16	8000	11200	8000	17000	11800
18	10000	14000	10000	21200	15000
20	12500	17000	12500	26500	19000
22	15000	21200	15000	31500	22400
26	21200	30000	21200	45000	31500
32	31500	45000	31500	67000	47500





G 80 AVRUPA TİP BAĞLANTI HAL.

MM	TON	\$/AD
6-8	1,12	4,716
7/8-8	2,00	6,737
10-8	3,15	7,534
13-8	5,30	12,949
16-8	8,00	20,261
20-8	12,50	59,164
22-8	15,00	84,476
26-8	21,20	171,878
32-8	31,50	180,881



G 80 SAPAN HALKASI

MM	TON	\$/AD
76-8	1,60	4,786
87-8	2,12	6,238
108-8	3,15	9,097
1310-8	5,30	16,446
1613-8	8,00	25,419
1816-8	11,20	46,648
2018-8	14,00	74,962
2220-8	17,00	99,543
2622-8	21,20	149,318
3226-8	31,50	248,156
3632-8	45,00	405,250
4036-8	56,00	506,130
72-8	63,00	889,467



G 80 KAYNAKLI ÇİFTLİ SAPAN HALKASI

MM	TON	\$/AD
6-8	2,36	14,430
7-8	3,15	15,430
8-8	4,25	25,317
10-8	6,70	37,720
13-8	11,20	67,572
16-8	17,00	110,564
18-8	21,20	116,206
20-8	26,50	361,441
22-8	31,50	474,632
26-8	45,00	912,711
28-8	50,00	1.277,202
32-8	63,00	1.801,793



G80 EMNİYET TETİK KİTİ

MM	\$/AD
7/8-8	5,783
10-8	6,252
13-8	14,638
16-8	25,880



G 80 ZEMİN BAĞLANTI HALKASI

TON	\$/AD
1.12T	9,178
2T	11,048
3.15T	15,648
5.3T	33,204
8T	56,960
10T	72,234
15T	132,097



EMNİYETLİ FIRDÖNDÜLÜ KANCA

MM	TON	\$/AD
6-8	1,12	22,797
7/8-8	2,00	29,734
10-8	3,15	54,233
13-8	5,30	108,280
16-8	8,00	205,957
18/20-8	12,50	400,447
22-8	15,00	594,935
26-8	21,20	882,967
32-8	31,50	3.044,057



G 80 PİMLİ SAPAN KANCASI

MM	TON	\$/AD
6-8	1,12	4,387
7/8-8	2,00	6,516
10-8	3,15	11,838
13-8	5,30	22,750
16-8	8,00	42,842
20-8	12,50	75,410
22-8	15,00	132,368
26-8	21,20	234,863



G 80 EMN. KUŞGÖZ KANCA

MM	TON	\$/AD
6-8	1,12	15,484
7/8-8	2,00	17,577
10-8	3,15	32,588
13-8	5,30	67,274
16-8	8,00	122,705
18/20-8	12,50	190,022
22-8	15,00	304,887
26-8	21,20	530,876
32-8	31,50	1.590,838



G 80 EMN. PİMLİ KANCA

MM	TON	\$/AD
6-8	1,12	16,564
7/8-8	2,00	20,035
10-8	3,15	35,540
13-8	5,30	75,183
16-8	8,00	151,261
18/20-8	12,50	212,075
22-8	15,00	315,058
26-8	21,20	581,236
32-8	31,50	2.225,278



G 80 ERKEK AYBOLT

MM	TON	\$/AD
8	00,80	4,671
10	01,00	5,336
12	02,00	6,340
16	04,00	7,400
24	08,00	18,850
27	10,00	19,200
42	24,00	85,000



FIRDÖNDÜLÜ AYBOLT

MM	TON	\$/AD
8	0,30	27,429
10	0,50	28,429
12	0,50	29,429
16	1,12	30,309
20	2,00	52,844
24	3,15	78,815
27	3,15	90,813
30	5,30	123,379
30	8,00	195,207
36	8,00	198,804



SLR 013 AĞIR TONAJLI KANCA

MM	Çalışma Yüğü	\$/AD
7/8-8	2,00	4,813
10-8	3,15	11,200
13-8	5,30	21,088
16-8	8,00	40,904
20-8	12,50	74,256
22-8	15,00	113,248
26-8	21,20	281,412
32-8	31,50	558,621



G 80 PİMLİ ZİNCİR KANCASI

MM	TON	\$/AD
6-8	1,12	3,672
7/8-8	2,00	4,551
10-8	3,15	10,537
13-8	5,30	22,756
16-8	8,00	39,921
20-8	12,50	70,056
22-8	15,00	87,921

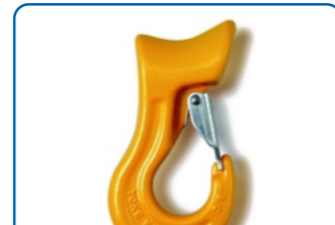

G80 KAYAR KANCA

MM	Tonaj	\$/AD
16	2,00	13,910
20	3,00	22,000



G80 GÖZLÜ DÖKÜMHANE KANCA

MM	Tonaj	\$/AD
7/8-8	2,00	15,080
10-8	3,15	35,050
13-8	5,30	59,110



G80 YEDEK PARÇA MANDAL EMN

MM	\$/AD
7/8	3,256
10	3,556
13	5,104
16	6,336



G 100 AVRUPA TİP BAĞLANTI HALI

MM	TON	\$/AD
8-10	2,50	9,808
10-10	4,00	10,738
13-10	6,70	20,924
16-10	10,00	34,665



G100 SAPAN HALKASI

MM	TON	\$/AD
16-10		13,151
18-10		21,417
22-10		36,142



G100 KAYNAKLI ÇİFTLİ SAPAN HALKASI

MM	TON	\$/AD
8-10		47,285
10-10		75,318
13-10		132,346



G 100 PİMLİ SAPAN KANCASI

MM	TON	\$/AD
8-10	2,50	19,047
10-10	4,00	34,010
13-10	6,70	61,215



G100 EMNİYETLİ PİMLİ KANCA

MM	TON	\$/AD
8-10	2,50	27,140
10-10	4,00	48,248
13-10	6,70	87,446



G100 PİMLİ ZİNCİR KANCASI

MM	TON	\$/AD
8-10	2,50	8,466
10-10	4,00	21,087
13-10	6,70	44,970



GR - 100 ZİNCİR SAPAN YAPIMI İÇİN MALZEME SEÇİM TABLOSU

Nominal Size of Sling	90°	β	Two Leg Slings		Triple and Four-Leg Slings		Choker Hitch *t
			0° < β ≤ 45°	45° < β ≤ 60°	0° < β ≤ 45°	45° < β ≤ 60°	
(in.)	(mm)	Single Leg t	t	t	t	t	t
7/32	6	1,40	2,00	1,40	3,00	2,12	1,12
1/4 (9/32)	7	2,00	2,80	2,00	4,20	3,00	1,60
5/16	8	2,50	3,55	2,50	5,30	3,75	2,00
3/8	10	4,00	5,60	4,00	8,00	6,00	3,20
1/2	13	6,70	9,50	6,70	14,0	10,0	5,35
5/8	16	10,0	14,0	10,0	21,2	15,0	8,00
3/4	19	14,0	20,0	14,0	30,0	21,0	11,2
7/8	22	18,8	26,5	18,8	39,4	28,0	15,0
7/8	23	21,0	29,5	21,0	44,4	31,5	16,8
1	26	27,0	38,0	27,0	57,0	40,0	21,2
1-1/4	32	40,0	56,0	40,0	85,0	60,0	32,5

ZİNCİR SAPANLARIN DOĞRU KULLANIMI

Zincir sapanlar sadece çalışma yük etiketinde belirtilen eğim açısı ile kullanılmalıdır. 15°'nin altında eğim açılarından kaçınılmalı ve zincir sapanlar asla 60°'yi aşan bir eğim açısı ile kullanılmamalıdır.

Zincirlerin kenar üzerinden yönlendirilmesi durumunda, hasarı önlemek veya yük kapasitesini azaltmak için koruyucu dolgu kullanılmalıdır. Ancak zincirler bir kiriş veya diğer yuvarlak şekilli bir yükte kıvrılırsa, çap, zincir aralığının en az üç katı olmalıdır. Daha küçük çaplar için zincirlerin çalışma yükleri % 50 azaltılmalıdır.

Muhtemel şok yük durumunda, zincirlerin çalışma yükü sınırı aşağıya indirilmelidir.

Kaldırma zincirleri ve bileşenleri 20.000 çevrim için boyutlandırılmıştır. Yüksek dinamik stres durumunda hasar riski vardır. "Kuzey-Güney Metal Ticaret Derneği"ne göre, yük kapasitesi sınırındaki gerilme, daha yüksek boyutlu zincirler kullanılarak bir bileşen olarak azaltılabilir.

Zincirlerin yük kapasiteleri, bireysel zincir ayaklarının yükünün simetrik olarak dağıldığı varsayımıyla tanımlanır. Aşağıdaki tüm koşullar yerine getirildiğinde yük simetrik olarak kabul edilebilir:

- Yük, belirtilen çalışma yük sınırının % 80'inden daha küçük olduğunda,
- Tüm zincir ayaklarının eğim açısı 15°'den az olmadığı,
- Tüm zincir ayaklarının eğim açısı eşit veya sapma açısı maksimum 15° olduğunda,
- 3 ve 4 bacaklı zincir sapan durumunda, sapan seviyesindeki karşılık gelen açılar birbirinden en fazla 15° sapmaktadır.

Bu parametreleri karşılamayınca, yük asimetrik kabul edilir ve kaldırma işlemini değerlendirmek için bir uzman aranmalıdır. Şüphe durumunda, yük kapasitesi kısıltma zincirinin sapanına indirilmelidir. Kullanılmayan bireysel zincir ayakları ana bağlantıya asılmalı ve çalışma yükü limiti buna göre azaltılmalıdır.



DIN 1480 ÇEKTİRME GÖZ + GÖZ

MM	\$/AD
10	3,746
12	4,826
16	9,557
20	16,947



DIN 1480 ÇEKTİRME GÖZ + KANCA

MM	\$/AD
10	3,746
12	4,976
16	9,952
20	18,027
22	27,020
24	30,130
30	48,840



ROLLER SHACKLE

MM	Tonaj	\$/AD
25	4,00	20,354

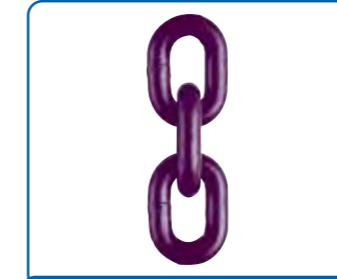

GRADE - 80 RETEZARNA ZİNCİR

MM	€/AD
6	17,670
8	24,120
10	34,560
13	56,940
16	87,070
20	165,210



GRADE - 100 RETEZARNA ZİNCİR

MM	€/AD
6	21,090
8	31,420
10	46,060
13	72,870
16	115,010
20	206,620



ÇEKTİRME KANCA + KANCA

MM	\$/AD
12	2,746
14	3,616
16	5,234



NORMAL ÇEKTİRME GÖZ + GÖZ

MM	\$/AD
5	0,571
6	0,585
8	0,918
10	1,210
12	2,746
14	3,616
16	5,234
20	9,265
24	16,913



ZİNCİR EN818-2 G80

Type	€/AD
6	29,84
7	37,85
8	42,95
10	54,79
13	97,17
16	144,94
18	
20	
22	
26	
32	

ANA HALKA G (3-4 BACAK İÇİN)

Type	€/AD
G 06/7.8	84,77
G 08.8	124,88
G 10.8	190,44
G 13.8	339,07
G 16.8	421,07
G 18.8	1.098,78
G 20.8	1.143,15
G 22.8	1.214,31
G 26.8	1.997,69
G 32.8	4.888,55
G 32.8 - neu	4.888,55

PİMLİ KISALTMA KANCASI PK

Type	€/AD
PK 07/8.8	40,90
PK 10.8	67,90
PK 13.8	125,38
PK 16.8	198,81
PK 20.8	310,29

EMNİYETLİ KUŞGÖZ KANCA HSB

Type	€/AD
HSB 06.8	105,96
HSB 07/8.8	106,74
HSB 10.8	153,37
HSB 13.8	255,29
HSB 16.8	470,82
HSB 20.8	859,29
HSB 22.8	

EMNİYETLİ FIRDÖNDÜLÜ KANCA WSB

Type	€/AD
WSB 06.8	253,80
WSB 07/8.8	262,88
WSB 10.8	313,62
WSB 13.8	521,71
WSB 16.8	881,26

KISALTMA KANCASI KVS

Type	€/AD
KVS 6	125,17
KVS 7	129,21
KVS 8	134,95
KVS 10	180,66
KVS 13.8 1)	216,95

ANA HALKA A

Type	€/AD
A 13	24,95
A 16	31,54
A 18	42,38
A 22	71,16
A 26	94,90
A 32	174,64
A 36	245,51
A/T 45	454,10
A/T 50	707,19
A/T 56	1.355,35

BAĞLANTI ELEMANI V

Type	€/AD
V 06.8 U	34,30
V 07.8 U	39,41
V 08.8 U	39,83
V 10.8 U	48,20
V 13.8 U	65,13
V 16.8 U	128,43
V 20.8 U	187,47
V 22.8 U/Z	298,24
V 26.8 U	504,84
V 32.8 U	827,04

KUŞGÖZ KANCA HS

Type	€/AD
HS 06.8 U	33,52
HS 07/8.8 U	42,88
HS 10.8 U	61,31
HS 13.8 U	108,51
HS 16.8 U	195,55
HS 20.8 U	336,52
HS 22.8 U	492,73
HS 26.8 U	896,15
HS 32.8 U	1.629,07

EMNİYETLİ PİMLİ KANCA HKSB

Type	€/AD
HKSB 06.8	112,55
HKSB 07/8.8	136,01
HKSB 10.8	160,96
HKSB 13.8	268,48
HKSB 16.8	485,71

GÖZLÜ DÖKÜMHANE KANCASI GH

Type	€/AD
GH 07/8.8	76,47
GH 10.8	108,51
GH 13.8	170,81
GH 16.8	255,58
GH 20.8	456,86

ANA HALKA T

Type	€/AD
T 87.8 (T 13)	30,76
T 108.8 (T 16)	40,61
T 1310.8 (T 20)	75,20
T 1613.8 (T 26)	110,78
T 2016.8 (T 32)	208,16
T 2220.8 (T 38)	382,23
T 2622.8 (A/T 45)	454,10
T 3226.8 (A/T 50)	707,19
T 3632.8 (A/T 56)	1.355,35

GÖZLÜ KISALTMA KANCASI P

Type	€/AD
P 06.8	21,40
P 07/8.8	25,44
P 10.8	47,13
P 13.8	94,34
P 16.8	139,27
P 20.8	218,01
P 22.8	381,95
P 26.8	1.485,76
P 32.8	2.134,41
P 32.8 - neu	2.134,41

PİMLİ SAPAN KANCASI HKS

Type	€/AD
HKS 06.8 U	42,38
HKS 07/8.8 U	56,49
HKS 10.8 U	82,50
HKS 13.8 U	136,01
HKS 16.8 U	237,43
HKS 20.8 U	441,55
HKS 22.8 U	693,80

G100 ZİNCİR		
Type	€/AD	
6 x 18	33,45	
7 x 21	43,45	
8 x 24	49,05	
10 x 30	62,44	
13 x 39	110,42	
16 x 48	164,93	
19 x 57	234,24	
20 x 60	286,48	
22 x 66	479,12	
26 x 78	867,80	

ANA HALKA A/S		
Type	€/AD	
A/S 13	26,72	
A/S 16	33,52	
A/S 18	45,43	
A/S 22	76,47	
A/S 26	102,70	
A/S 32	187,68	
A/S 36	264,15	
A/S 45	489,46	
A/S 50	761,41	
A/S 56	1.459,54	

ANA HALKA GTVK/S 4		
Type	€/AD	
GTVK/S 4-6	479,12	
GTVK/S 4-7	740,72	
GTVK/S 4-8	772,75	
GTVK/S 4-10	1.032,87	
GTVK/S 4-13	1.915,69	
GTVK/S 4-16	2.637,77	

EMNİYETLİ PİMLİ KANCA HKS/S		
Type	€/AD	
HKS/S 6	121,34	
HKS/S 7	145,29	
HKS/S 8	146,07	
HKS/S 10	173,08	
HKS/S 13	288,39	
HKS/S 16	521,71	

PİMLİ DÖKÜMHANE KANCASI GHK/S		
Type	€/AD	
GHK/S 8	121,91	
GHK/S 10	173,08	
GHK/S 13	257,84	

EMNİYETLİ FIRDÖNDÜLÜ KANCA WSB/S		
Type	€/AD	
WSB/S 6	273,22	
WSB/S 7/8	283,08	
WSB/S 10	337,79	
WSB/S 13	561,90	
WSB/S 16	949,16	

ANA HALKA GTVK/S		
Type	€/AD	
GTVK/S 1-6	151,67	
GTVK/S 1-7	158,48	
GTVK/S 1-8	160,18	
GTVK/S 1-10	210,64	
GTVK/S 1-13	419,09	
GTVK/S 1-16	660,98	

ANA HALKA G/S		
Type	€/AD	
G/S 6	91,57	
G/S 7/8	134,24	
G/S 10	205,11	
G/S 13	365,86	
G/S 16	453,39	
G/S 19/20	1.182,98	
G/S 22	1.308,15	
G/S 26	2.151,35	

BAĞLANTI ELEMANI V/S		
Type	€/AD	
V/S 6	37,07	
V/S 7	42,17	
V/S 8	42,88	
V/S 10	47,70	
V/S 13	70,10	
V/S 16	139,27	
V/S 19/20	202,85	
V/S 22	300,72	
V/S 26	538,94	

EMNİYETLİ KUŞGÖZ KANCA HSB/S		
Type	€/AD	
HSB/S 6	113,83	
HSB/S 7/8	115,03	
HSB/S 10	165,49	
HSB/S 13	275,28	
HSB/S 16	506,62	
HSB/S 19/20	924,92	
HSB/S 22	1.170,15	

EMNİYETLİ GÖZLÜ ZİNCİR KANCASI PS/S		
Type	€/AD	
PS/S 7/8	53,51	
PS/S 10	76,97	
PS/S 13	146,57	
PS/S 16	213,19	

GÖZLÜ DÖKÜMHANE KANCASI GH/S		
Type	€/AD	
GH/S 7/8	82,78	
GH/S 10	116,02	
GH/S 13	184,20	
GH/S 16	275,78	
GH/S 19/20	492,51	

ANA HALKA GTVK/S 2		
Type	€/AD	
GTVK/S 2-6	204,90	
GTVK/S 2-7	306,75	
GTVK/S 2-8	328,51	
GTVK/S 2-10	431,91	
GTVK/S 2-13	837,39	
GTVK/S 2-16	1.420,41	

ANA HALKA GL/S 1		
Type	€/AD	
GL/S 1-10	264,93	
GL/S 1-13	238,21	
GL/S 1-16	306,54	
GL/S 1-19/22	471,32	

KISALTMA KANCASI VK/S		
Type	€/AD	
VK/S 6	73,43	
VK/S 7	111,27	
VK/S 8	117,58	
VK/S 10	141,75	
VK/S 13	241,68	
VK/S 16	431,13	

CİRCİRLİ GERDİRME GÖZLÜ RLS/S		
Type	€/AD	
RLS/S 7/8	112,76	
RLS/S 10	154,15	
RLS/S 13	201,29	

PİMLİ SAPAN KANCASI HKS/S		
Type	€/AD	
HKS/S 6	45,93	
HKS/S 7	58,05	
HKS/S 8	60,81	
HKS/S 10	89,02	
HKS/S 13	146,07	
HKS/S 16	255,58	
HKS/S 19/20	475,79	
HKS/S 22	747,03	

ANA HALKA GL/S 2		
Type	€/AD	
GL/S 2-6/7/8/4-6	332,05	
GL/S 2-10/4-7/8	346,93	
GL/S 2-13/4-10	466,78	
GL/S 2-16/4-13	619,38	
GL/S 2-19/4-16	676,15	

PİMLİ ZİNCİR KANCASI PK/S		
Type	€/AD	
PK/S 6	41,11	
PK/S 7	42,17	
PK/S 8	43,66	
PK/S 10	73,21	
PK/S 13	135,23	
PK/S 16	214,47	
PK/S 19/20	334,32	
PK/S 22	495,99	



G120 Sun Alloy SUN Zincir			
Kalınlık (mm)	Yük Kap. (kg)	Kopma Yüğü (kn)	€/Metre
7x21	2360	92,60	51,95
8x24	3000	118,00	57,69
10x30	5000	196,00	74,35
13x39	8000	319,00	127,50
16x48	12200	479,00	190,02



TEKLİ PİMLİ SAPAN HALKASI GTVK/SUN-1			
Çap (mm)	Yük Kap. (0-45°) kg	Yük Kap. (45-60°) kg	€/Adet
7	3350	2360	182,93
8	4250	3000	184,91
10	7100	5000	242,96
13	11200	8000	483,65
16	17000	12200	762,69



ÇİFTLİ PİMLİ SAPAN HALKASI GTVK/SUN-1			
Çap (mm)	Yük Kap. (0-45°) kg	Yük Kap. (45-60°) kg	€/Adet
7	3350	2360	414,08
8	4250	3000	432,05
10	7100	5000	577,83
13	11200	8000	1.071,07
16	17000	12200	1.474,88



EMNİYETLİ PİMLİ SAPAN KANCASI HKSB/SUN		
Çap (mm)	Yük Kap. kg	€/Adet
7	2360	159,19
8	3000	160,67
10	5000	198,03
13	8000	330,00
16	12200	595,92



TEKLİ SAPAN HALKASI GTKR/SUN-1		
Çap (mm)	Yük Kap. (0-45°) kg	€/Adet
7	2360	100,15
8	3000	103,90
10	5000	139,55
13	8000	281,80
16	12200	445,10



ÇİFTLİ SAPAN HALKASI GTKR/SUN-2			
Çap (mm)	Yük Kap. (0-45°) kg	Yük Kap. (45-60°) kg	€/Adet
7	3350	2360	171,52
8	4250	3000	171,52
10	7100	5000	225,53
13	11200	8000	502,79
16	17000	12200	820,24



ÇİFTLİ SAPAN HALKASI GTKR/SUN-4			
Çap (mm)	Yük Kap. (0-45°) kg	Yük Kap. (45-60°) kg	€/Adet
7	5000	3550	521,71
8	6300	4500	521,71
10	10600	7500	676,43
13	17000	11800	1.236,99
16	25600	18300	1.606,11



PİMLİ SAPAN KANCASI HKS/SUN		
Çap (mm)	Yük Kap. kg	€/Adet
7	2360	67,33
8	3000	70,38
10	5000	102,41
13	8000	168,75
16	12200	296,19

Maximum Working Load Limit for Sun Alloy Chains										
Safety Factor	1-leg Chains		2-leg Chains		3- and 4-leg Chains					
	Angle of Inclination	Load Factor	Angle of Inclination	Load Factor	Angle of Inclination	Load Factor	Angle of Inclination	Load Factor		
4	--	1	up to 45°	1,4	45°-60°	1	up to 45°	2,1	45°-60°	1,3
Ø	Load Capacity [kg]									
7	2,360	1,900	3,350	2,360	2,650	1,900	5,000	3,550		
8	3,000	2,360	4,250	3,000	3,350	2,360	6,300	4,500		
10	5,000	4,000	7,100	5,000	5,600	4,000	10,600	7,500		
13	8,000	6,300	11,200	8,000	9,000	6,300	17,000	11,800		
16	12,200	9,700	17,000	12,200	13,600	9,700	25,600	18,300		

KROM ZİNCİR & ZİNCİR EKİPMANLARI G6 PLUS



SSWI ZİNCİR KİLİDİ	
Tonaj	€/Adet
SSWI 0,63T	37,26
SSWI 0,9T	80,55
SSWI 1,6T	85,25
SSWI 2,5T	190,05
SSWI 4,25T	356,11
SSWI 6,3T	658,79



CWI BAĞLANTI HALKASI			
Code	Art. No.	Pack. unit	€/Adet
CWI 5	55642	1,00	206,49
CWI 6	74344	1,00	212,99
CWI 7	75404	1,00	217,69
CWI 8	74355	1,00	263,57
CWI 10	75390	1,00	345,96
CWI 13	75392	1,00	408,54
CWI 16	75396	1,00	599,91



HSWI GÖZLÜ SAPAN KANCASI	
Code	€/Adet
HSWI 5/6	237,25
HSWI 7/8	375,40
HSWI 10	645,78
HSWI 13	886,68
HSWI 16	1.283,48



VLWI KISALTMA KANCASI			
Code	Art. No.	Pack. unit	€/Adet
VLWI 5/6	62906	1,00	362,92
VLWI 7/8	62927	1,00	509,96
VLWI 10	62655	1,00	675,22
VLWI 13	62894	1,00	991,22
VLWI 16	62928	1,00	1.738,90

I-leg chains		II-leg chains			
		0°-45°	45°-60°	0°-45°	45°-60°
-	-	1.4	1	1.12	0.8
1	0.8	1.4	1	1.12	0.8
Load capacity [kg]					
400	320	560	400	450	320
320	256	450	320	355	256
630	500	850	630	700	500
500	400	700	500	560	400
900	720	1,250	900	1,000	720
750	600	1,000	750	800	600
1,250	1,000	1,750	1,250	1,400	1,000
1,000	800	1,400	1,000	1,120	800
1,600	1,280	2,200	1,600	1,800	1,280
1,250	1,000	1,700	1,250	1,400	1,000
2,500	2,000	3,500	2,500	2,800	2,000
2,000	1,600	2,800	2,000	2,240	1,600

KROM ZİNCİR & ZİNCİR EKİPMANLARI G6 PLUS



KROM YÜK ZİNCİRİ WOX	
Kalınlık (mm)	€/Adet
WOX 4	62,09
WOX 5	73,78
WOX 6	102,91
WOX 7	137,50
WOX 8	164,21
WOX 10	260,32
WOX 13	441,67
WOX 16	689,20
WOX 20	1.469,88
WOX 26	1.863,13
WOX-S 5	88,24



SAPAN HALKASI AWI	
Kalınlık (mm)	€/Adet
AWI 8	37,79
AWI 10	68,29
AWI 13	91,27
AWI 16	113,68
AWI 18	144,18
AWI 22	244,01
AWI 26	391,84
AWI 32	688,27
AWI 36	1.008,40
AWI 45	1.768,65



BAĞLANTI EKİ BWI	
Kalınlık (mm)	€/Adet
BWI 7	29,18
BWI 9	35,20
BWI 10	50,84
BWI 13	83,45
BWI 16	105,86
BWI 20	147,03
BWI 22	198,14
BWI 26	330,32
BWI 32	648,37



VWI ÇİFTLİ SAPAN HALKASI	
Kalınlık (mm)	€/Adet
VWI 4	170,88
VWI 5	311,21
VWI 6/7	468,37
VWI 8	764,70
VWI 10	1.343,08
VWI 13	2.247,77
VWI 16	4.018,76

Gözlü Polyester Sapan USD Fiyat Listesi

TON	1 MT	1,5 MT	2 MT	3 MT	4 MT	5 MT	6 MT	8 MT	10 MT	12 MT	15 MT	16 MT	18 MT	20 MT
1	3,60	3,90	4,50	6,15	7,35	9,45	11,00	14,15	17,30	21,50	27,90	30,00	34,30	38,60
2	4,20	4,80	6,20	8,25	10,30	12,80	15,20	20,60	25,70	30,95	38,70	41,25	47,25	55,60
3	5,80	7,00	7,80	10,95	14,80	17,70	21,00	26,80	35,00	41,20	55,90	59,85	68,80	77,15
4	7,25	9,35	10,90	15,25	19,50	24,30	28,80	36,95	45,70	55,90	68,75	73,00	85,50	94,50
5	8,50	12,25	14,90	20,50	26,25	32,50	38,50	52,50	65,50	76,85	96,50	105,20	120,00	135,00
6			18,00	25,50	33,25	39,50	47,00	64,50	80,00	100,00	125,00	135,00	155,00	170,00
8			26,00	38,00	42,00	58,25	71,00	91,75	112,00	132,00	165,00	175,00	195,00	220,00
10			38,00	47,50	63,80	78,25	92,50	117,50	143,75	175,00	225,00	242,00	270,00	300,00
12			41,00	59,00	78,00	102,00	119,00	154,00	191,00	227,00	296,00	315,00	355,00	395,00
15				80,00	102,00	125,00	145,00	185,00	225,00	270,00	345,00	370,00	420,00	470,00
20				99,96	141,40	167,00	197,64	256,78	314,00	372,00	486,00	526,00	589,00	645,00
25				140,00	175,00	215,00	255,00	335,00	415,00	495,00	620,00	660,00	740,00	820,00
30				160,00	210,00	260,00	305,00	400,00	495,00	590,00	730,00	780,00	870,00	960,00

GÖZLÜ POLYESTER SAPAN 6:1 ve 7:1 FİYAT LİSTESİDİR.

TEK BACAĞI SAPANLARIN KULLANIM BİLGİLERİ

- Güvenli çalışma yükleri sadece yeni sapanlar için geçerlidir.
- Güvenli çalışma yükleri belirlenirken güvenlik katsayısı 7:1 alınmıştır.

ÇAP (mm)	DİK KALDIRMA (kg)	AÇISAL KALDIRMA				
		90 DERECE	60 DERECE	45 DERECE	30 DERECE	BOĞDURMA
12	1.920	3.840	3.322	2.714	1.920	1.353
16	3.385	6.770	5.856	4.785	3.385	2.386
18	4.070	8.140	7.041	5.753	4.070	2.869
20	4.850	9.700	8.391	6.855	4.850	3.419
22	5.820	11.640	10.069	8.227	5.820	4.103
24	6.840	13.680	11.833	9.668	6.840	4.822
28	8.880	17.760	15.362	12.552	8.880	6.260
32	11.365	22.730	19.661	16.064	11.365	8.011
38	15.150	30.300	26.210	21.415	15.150	10.680
42	17.775	35.550	30.751	25.125	17.775	12.530
44	19.085	38.170	33.017	26.977	19.085	13.453
48	22.290	44.580	38.562	31.507	22.290	15.713

- Açılı kaldırmalarda D/d oranı minimum 25:1 olarak alınmıştır. (D: Temas edilen yüzeyin minimum çapı, d: halat çapı)
- D/d oranı 25:1 oranından daha az olursa aşağıdaki tablo takip edilir.

D/d	20	10	5	2	1
Uygulanabilir Kuvvet	%95	%85	%75	%60	%50

- Açılı kaldırmalarda açının 30 dereceden daha az olması önerilmez. 85 dereceden yüksek olduğu durumlarda dik kaldırma yükü hesaplanır.

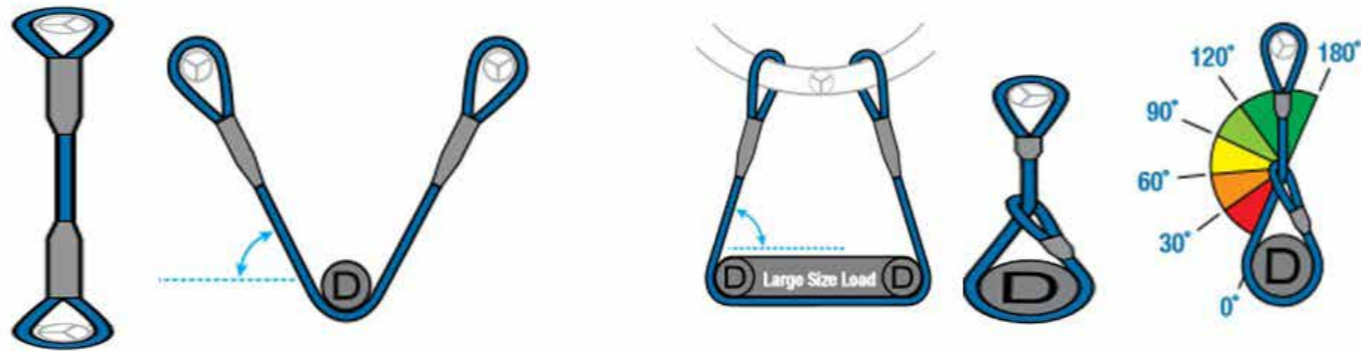

GROMMET SAPANLARIN KULLANIM BİLGİLERİ

- Güvenli çalışma yükleri sadece yeni sapanlar için geçerlidir.
- Güvenli çalışma yükleri belirlenirken güvenlik katsayısı 5:1 alınmıştır.

ÇAP (mm)	DİK KALDIRMA	AÇISAL KALDIRMA				
		90 DERECE	60 DERECE	45 DERECE	30 DERECE	BOĞDURMA
12	3.072	6.144	5.315	4.357	3.072	2.163
16	5.416	10.832	9.370	7.682	5.416	3.814
18	6.512	13.024	11.266	9.236	6.512	4.586
20	7.760	15.520	13.425	11.006	7.760	5.465
22	9.312	18.624	16.110	13.207	9.312	6.558
24	10.944	21.888	18.933	15.522	10.944	7.707
28	14.208	28.416	24.580	20.151	14.208	10.006
32	18.184	36.368	31.458	25.790	18.184	12.806
38	24.240	48.480	41.935	34.380	24.240	17.070
42	28.440	56.880	49.201	40.336	28.440	20.028
44	30.536	61.072	52.827	43.309	30.536	21.504
48	35.664	71.328	61.699	50.582	35.664	25.115

- Açılı kaldırmalarda D/d oranı minimum 25:1 olarak alınmıştır. (D: Temas edilen yüzeyin minimum çapı, d: halat çapı)
- D/d oranı 25:1 oranından daha az olursa aşağıdaki tablo takip edilir.

D/d	5	2	1
Uygulanabilir Kuvvet	%94	%75	%63

- *Fiyat bilgisi için lütfen müşteri temsilcimizle iletişime geçiniz.

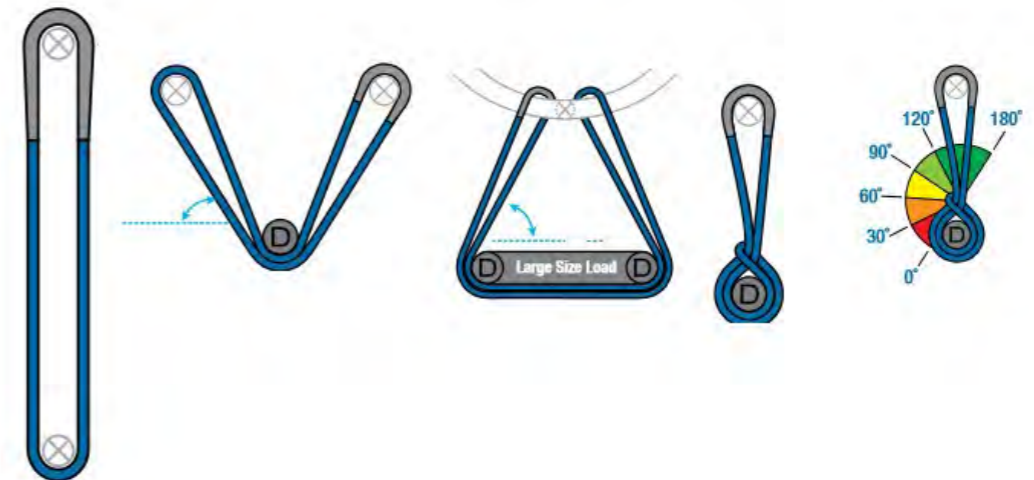



CERASKAL - HSZ

TON	Zincir Boyu MT	\$/AD
1	3	202,275
2	3	295,800
3	3	348,000
5	3	556,075
1	5	246,500
2	5	370,475
3	5	447,325
5	5	691,650
10	5	1.283,975



HUBZUG - HSH - A

TON	Zincir Boyu MT	\$/AD
0,75	1,5	201,550
1,5	1,5	250,125
3	1,5	377,725
6	1,5	553,175



SAC KAPMA - CDH

TON	Çene Açıklığı	\$/AD
1	0-15 MM	118,900
2	0-25 MM	142,100
3	0-25 MM	212,0625
5	0-30 MM	315,375



FIÇI SAPANI GR-8

TON	\$/AD
1	95,70



HALAT KAPMA

TON	\$/AD
0,5	28,6375
1	35,525
2	60,175
3	111,650



KALICI MANYETİK KALDIRMA

TON	\$/AD
0,6	610,45
1	897,55
2	2.175,00
3	3.335,00
6	11.890,00



HALATLI TRIFOR

TON	Halat Boyu	\$/AD
0,8	20 MT	348,725
1,6	20 MT	523,450
3,2	20 MT	841,000



HALATLI ÇEKTİRME

TON	\$/AD
1T	34,328
2T	35,474
3T	50,928
5T	67,519



PROFİL KAPMA - IE TİPİ KALDIRMA JG

TON	Çene Açıklığı	\$/AD
1	75-230 MM	90,00
2	75-230 MM	108,00
3	80-320 MM	188,00



BORU KAPMA - AĞIR HİZMET TİPİ KALDIRMA YG

TON	Çene Açıklığı	\$/AD
1	50-100 MM	209,00
2	80-100 MM	451,00
3	120-220 MM	913,00



YATAY SAC KAPMA YPC

TON	Çene Açıklığı	\$/AD
1,5	0-50 MM	120,00
3	0-50 MM	172,00



YATAY SAC KAPMA PPD

TON	Çene Açıklığı	\$/AD
0,8	0-25 MM	53,00
1	0-30 MM	76,00
1,6	0-30 MM	92,00
2	0-40 MM	123,00
3,2	0-45 MM	139,00
4	0-50 MM	171,00
5	0-55 MM	214,00



KABLO ÇORABI

KG	Ağız Açıklığı	\$/AD
1100	19-35 MM	49,300
2000	25-50 MM	71,050
2000	38-60 MM	82,650



YÜK TAŞIMA ARABASI

TONAJ (T)	\$/AD
8	480,675
16	1.048,350



MAKİNE KRİKOSU

TONAJ (T)	\$/AD
5	229,10
10	398,75



PEHLİVAN KRİKO

TONAJ (T)	\$/AD
1,5	359,600
3	472,700
5	587,250
10	841,000



TRANSPALET

TON	\$/AD
2,5	888,88



VİNÇ ŞARYOSU

TON	Çalıştığı NPI	\$/AD
0,5	75-125 MM	89,175
1	75-125 MM	131,90
2	100-150 MM	205,000
3	100-150 MM	325,000
5	125-175 MM	378,450



KADEMELİ MAKİNE KRİKO

TONAJ (T)	\$/AD
3	566,250
5	731,250



İP HALAT TUTUCU

MM	\$/AD
8	17,790



ÇELİK KARABİNA

MM	\$/AD
10	7,419



KANCA KARABİNA

	\$/AD
	12,855



PROFESYONEL BALANSER		
kg	Uzunluk mt	\$/ADET
5 - 7	1,9	FİYAT SORUNUZ
6 - 9	1,8	FİYAT SORUNUZ
10 - 15	1,8	FİYAT SORUNUZ
15 - 22	1,5	FİYAT SORUNUZ
22 - 30	1,5	FİYAT SORUNUZ
30 - 40	1,5	FİYAT SORUNUZ
40 - 50	1,5	FİYAT SORUNUZ
50 - 60	1,5	FİYAT SORUNUZ
60 - 70	1,5	FİYAT SORUNUZ
70 - 80	1,5	FİYAT SORUNUZ
80 - 100	1,5	FİYAT SORUNUZ
100 - 120	1,5	FİYAT SORUNUZ
120 - 140	1,5	FİYAT SORUNUZ
140 - 160	1,5	FİYAT SORUNUZ





PLAW PEWAG WINNER PROFILIFT ALPHA

KOD	MM	€/AD
PLAW 0,3 T	M8	302,89
PLAW 0,63 T	M10	305,52
PLAW 1,0 T	M12	305,22
PLAW 1,5 T	M16	333,50
PLAW 2,5 T	M20	375,57
PLAW 4 T	M24	445,92
PLAW 6 T	M30	706,14
PLAW 8 T	M36	1.248,60
PLAW 10 T	M42	1.493,24
PLAW 20 T	M48	1.970,37



PLBW PEWAG WINNER PROFILIFT BETA

KOD	MM	€/AD
PLBW 0,3 T	M8	277,88
PLBW 0,6 T	M10	282,30
PLBW 1,0 T	M12	285,82
PLBW 1,3 T	M14	362,02
PLBW 1,6 T	M16	382,37
PLBW 2 T	M18	410,30
PLBW 2,5 T	M20	419,72
PLBW 3 T	M22	637,57
PLBW 4 T	M24	639,31
PLBW 5 T	M27	712,89
PLBW 6,3 T	M30	720,87
PLBW 8 T	M33	1.657,76
PLBW 15 T	M48	2.428,94



PLGW PEWAG WINNER PROFILIFT GAMM

KOD	MM	€/AD
PLGW 0,3 T	M8	155,44
PLGW 0,5 T	M10	163,97
PLGW 0,7 T	M12	177,51
PLGW 1,5 T	M16	205,74
PLGW 2,3 T	M20	256,94
PLGW 3,2 T	M24	337,02
PLGW 4,9 T	M30	514,83
PLGW 7 T	M36	707,92
PLGW 9 T	M42	970,18
PLGW 12 T	M48	1.394,02



PLDW PEWAG WINNER PROFILIFT DELTA

KOD	MM	€/AD
PLDW 0,3 T	M8	281,11
PLDW 0,5 T	M10	282,00
PLDW 0,7 T	M12	282,89
PLDW 1 T	M14	297,58
PLDW 1,5 T	M16	304,67
PLDW 2,5 T	M20	383,80
PLDW 4 T	M24	520,09
PLDW 6,7 T	M30	676,42
PLDW 8 T	M36	970,47
PLDW 10 T	M42	1.059,08
PLDW 13 T	M48	1.148,24



PLE/N PEWAG WINNER PROFILIFT ETA

KOD	TON	€/AD
PLE 6/N	1,12 T	45,05
PLE 8/N	2,5 T	63,31
PLE 10/N	3,15 T	66,23
PLE 13/N	5,3 T	110,69
PLE 16/N	8 T	154,25
PLE 22/N	15 T	389,41



RGS DÖVME ÇELİK AYBOLT

KOD	MM	€/AD
RGS	8	FIYAT SORUNUZ
RGS	10	FIYAT SORUNUZ
RGS	12	FIYAT SORUNUZ
RGS	14	FIYAT SORUNUZ
RGS	16	FIYAT SORUNUZ
RGS	20	FIYAT SORUNUZ
RGS	24	FIYAT SORUNUZ



MİNİ SPANZET

MT	\$/AD
4	FIYAT SORUNUZ
6	FIYAT SORUNUZ



OTO YÜK BANDI - SPANZET (EMNİYET KEMERLİ)

MT	\$/AD
8	FIYAT SORUNUZ
10	FIYAT SORUNUZ
12	FIYAT SORUNUZ



OTO YÜK BANDI - SPANZET (POLİ PROPİLEN)

MT	TONAJ	\$/AD
8	2 T	FIYAT SORUNUZ
10	2 T	FIYAT SORUNUZ



OTO YÜK BANDI - SPANZET (SARI POLYESTER)

MT	TONAJ	\$/AD
8	5 T	FIYAT SORUNUZ
10	5 T	FIYAT SORUNUZ
12	5 T	FIYAT SORUNUZ



ÖRME KOLON

MM	\$/MT
2" EMN. KEM. TİPİ	FIYAT SORUNUZ
2" DOKUMA TİPİ	FIYAT SORUNUZ
2" DOKUMA TİPİ 5 T	FIYAT SORUNUZ
1,5" DOKUMA TİPİ	FIYAT SORUNUZ
1" DOKUMA TİPİ	FIYAT SORUNUZ

Made in Holland



TS -R KROM SAÇ KAPMA

ÜRÜN ADI	ÇENE AÇIKLIĞI (MM)	€/AD
0,75 TON TSR	0-13	1.142,10
1 TON TSE-R	0-25	1.514,70
2 TON TSE-R	0-35	2.025,00
3 TON TSE-R	0-35	2.033,10
4,5 TON TSE-R	0-45	2.960,55
6 TON TSE-R	0-50	3.964,95
7,5 TON TSE-R	0-55	4.531,95



TSHP SAÇ KAPMA

ÜRÜN ADI	ÇENE AÇIKLIĞI (MM)	€/AD
1 TON TSHP	0-80	2.972,70
1,5 TON TSHPA	0-155	4.045,95



TPH - TPH - HD TİP BORU KANCASI TPH

ÜRÜN ADI	ÇENE AÇIKLIĞI (MM)	€/TK
1,5 TON TPH	40	943,65
3 TON TPH	40	1.061,10
4 TON TPH	50	1.348,65
6 TON TPH	50	1.506,60
8 TON TPH	70	1.972,35
10 TON TPH	70	2.227,50
12 TON TPH	70	2.494,80
15 TON TPH	70	4.325,40
20 TON TPH	60	5.139,45

Made in Holland



TSE TİP DİKEY SAC KAPMA

ÜRÜN ADI	ÇENE AÇIKLIĞI (MM)	€/AD
0,75 TON TS	0-13	846,45
1 TON TSE	0-25	1.048,95
2 TON TSE	0-35	1.174,50
3 TON TSE	0-35	1.239,30
4,5 TON TSE	0-45	1.615,95
6 TON TSE	0-50	2.328,75
7,5 TON TSE	0-55	2.624,40
9 TON TS	0-55	3.025,35



FHX - FHSX YATAY TİP SAC KAPMA

ÜRÜN ADI	ÇENE AÇIKLIĞI (MM)	€/TK
1 TON FHX	0-35	996,30
2 TON FHX	0-60	1.255,50
3 TON FHX	0-60	1.607,85
4 TON FHX	0-60	1.939,95
6 TON FHX	0-60	2.215,35
8 TON FHX	0-60	2.741,85
10 TON FHX	0-60	3.248,10
12 TON FHX	0-60	3.730,05
15 TON FHX	0-60	6.111,45



TSU/ TSEU TİP DİKEY SAC KAPMA

ÜRÜN ADI	ÇENE AÇIKLIĞI (MM)	€/AD
0,75 TSU	0 - 13	1.081,35
1 TSEU	0 - 25	1.433,70
2 TSEU	0 - 35	1.680,75
3 TSEU	0 - 35	1.818,45
4,5 TSU	0 - 25	2.203,20
4,5 TSEU	0 - 45	2.349,00
6 TSU	0 - 32	2.401,65
6 TSEU	0 - 50	2.916,00
7,5 TSU	0 - 40	2.964,60
7,5 TSEU	0 - 55	3.681,45
9 TSU	0 - 55	4.815,45
12 TSU	0 - 52	5.346,00
15 TSU	0 - 76	8.958,60



TNMH SAÇ KAPMA

ÜRÜN ADI	ÇENE AÇIKLIĞI (MM)	€/TK
1 TON TNMH	0-25	2.195,10
2 TON TNMH	0-45	2.907,90
3 TON TNMH	0-45	3.478,95
4 TON TNMH	0-50	4.394,25
6 TON TNMH	0-50	5.127,30



FBK SAÇ KAPMA

ÜRÜN ADI	ÇENE AÇIKLIĞI (MM)	€/AD
1 TON FBK	0-15	1.247,40
1,5 TON FBK	0-20	1.518,75
3 TON FBK	0-25	1.822,50



TSCC SAÇ KAPMA

ÜRÜN ADI	ÇENE AÇIKLIĞI (MM)	€/AD
0,5 TON TSCC	0-35	919,35
1 TON TSCC	0-30	1.312,20
1,5 TON TSCC	0-40	1.494,45
3 TON TSCC	0-60	2.162,70
6 TON TSCC	0-100	3.657,15



VARİL KALDIRMA TVKH

ÜRÜN ADI	€/AD
600 KG	842,40



TBLC TİP YAKAY BLOK KISKACI

ÜRÜN ADI	ÇENE AÇIKLIĞI (MM)	€/AD
0,5 TON	30-110	3.061,80
1 TON	100-230	3.207,60
2 TON	220-360	3.973,05
3 TON	350-500	4.179,60



FBK TİP DİKEY SAC KAPMA

ÜRÜN ADI	ÇENE AÇIKLIĞI (MM)	€/AD
1 TON	0-15 MM	570,23
1,5 TON	0-20 MM	694,97
3 TON	0-25 MM	833,57

Avrupa Mühendisliğinin Kalitesiyle Üretilen OX Ürünleri Endüstriyel Ve Denizcilik Sektörlerinde, Yük Kaldırma Ekipmanları Sektöründe Lider Firmadır.

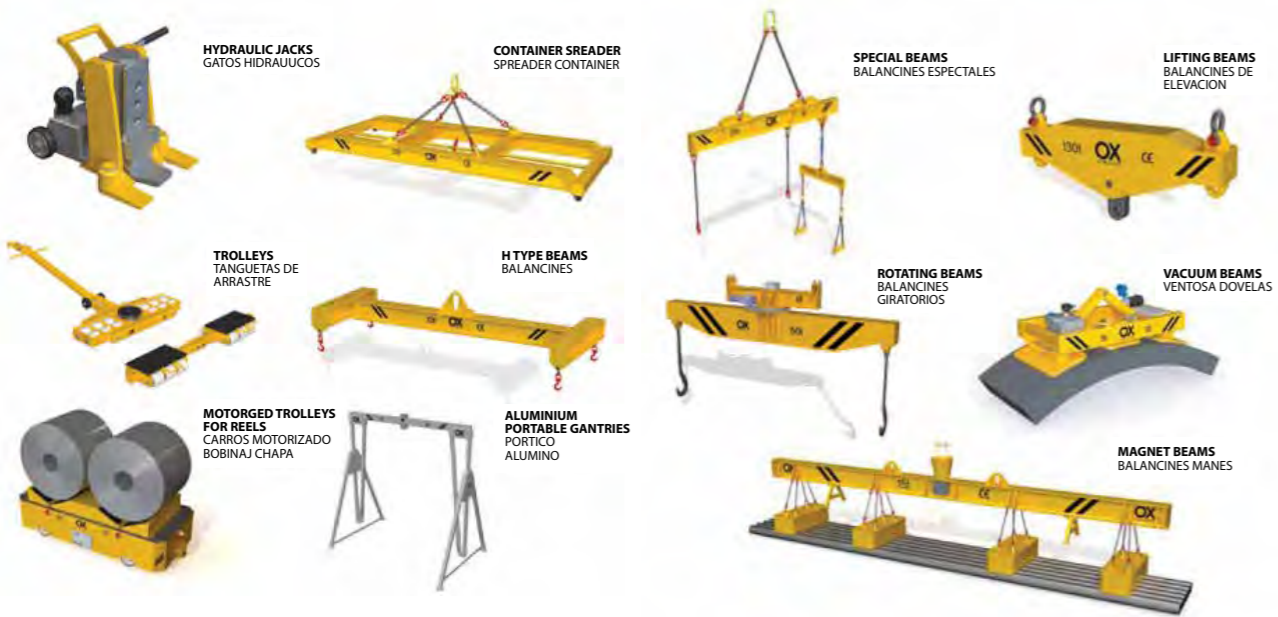

Türkiye Distribütörü

ZİNCİR GRUPLARI



DIN 766 KALİBRE ZİNCİR \$/KG

MM	Siyah	Galvaniz
5		
6		
7		
8		
10		
11		
12		
13		
14		
16		
18		

FIYAT SORUNUZ



DIN 5685 SANAYİ ZİNCİRİ \$/KG

MM	Galvanizli Çuval	Galvanizli Makara	Siyah
5			
6			
8			
10			
12			
14			
16			

FIYAT SORUNUZ



PLASTİK ZİNCİR

\$/MT

FIYAT SORUNUZ



KANCALI ZİNCİR

TON	\$/AD
2	
5	
10	

FIYAT SORUNUZ

MAKARA GRUBU



JAPON TİP MAKARA

SIZE	WLL (TON)	\$/AD
4	2	87,819
5	3	128,060
6	5	187,480

\$/AD

FIYAT SORUNUZ

MANDİKAPAN MAKARALAR TEKLİ

SIZE	WLL (TON)	\$/AD
75X1	0,50	34,860
100X1	1	50,708
125X1	1,5	79,223
150X1	2	119,895
175X1	2,5	185,918
180X1	3	190,918
200X1	4	226,058
250X1	5	295,778



MANDİKAPAN MAKARALAR ÇİFTLİ

SIZE	WLL (TON)	\$/AD
75X2	0,50	51,758
100X2	1	82,395
125X2	1,5	119,363
150X2	2	190,140
180X2	3	266,198
200X2	4	340,140
250X2	5	435,210





VİNÇLER



EL VİNCİ

LB	\$/AD
600	38,298
800	40,298
1200	49,310
2000	72,762
2500	84,250



RÖMORK KİLİDİ - TOPUZLU

	\$/AD
KİLİDİ	52,62
TOPUZU	16,49



RÖMORK TEKERİ

	\$/AD
	125,325



MAKARA TAKOZ

MM	\$/AD
15	FIYAT SORUNUZ
20	FIYAT SORUNUZ
25	FIYAT SORUNUZ



YAN DAYANMA RULOSU

	\$/AD
	FIYAT SORUNUZ



V TİPİ TAKOZ

	\$/AD
KÜÇÜK	FIYAT SORUNUZ
BÜYÜK	FIYAT SORUNUZ



MİNİ ELEKTRİKLİ VİNC

KG	\$/AD
125-250	FIYAT SORUNUZ
250-500	FIYAT SORUNUZ
400-800	FIYAT SORUNUZ
600-1200	FIYAT SORUNUZ



YERLİ VİNC 4 HAREKETLİ

KG	\$/AD
1T/6MT	FIYAT SORUNUZ
2T/6MT	FIYAT SORUNUZ
3T/6MT	FIYAT SORUNUZ
5T/6MT	FIYAT SORUNUZ



YERLİ VİNC 2 HAREKETLİ

KG	\$/AD
1T/10MT	FIYAT SORUNUZ
2T/10MT	FIYAT SORUNUZ
3T/10MT	FIYAT SORUNUZ
5T/10MT	FIYAT SORUNUZ



MİNİ VİNC ŞARYOSU

	\$/TK
	FIYAT SORUNUZ



C PROFİL - KABLO ARABASI

	\$/AD
	FIYAT SORUNUZ





KAPALI TİP SOKET		
MBL (Tons)	MM (Çelik Halat)	€/AD
40 GL	18-19	123,54
55 GL	20-22	128,76
75 GL	23-26	170,52
90	27-30	215,76
125	31-36	318,42
150	37-39	393,24
170	40-42	509,82
225	43-48	767,34
280	49-54	1.092,72
360	55-60	1.345,02
450	61-68	1.656,48



AÇIK TİP SOKET		
MBL (Tons)	MM (Çelik Halat)	€/AD
40 GL	18-19	133,00
55 GL	20-22	186,20
75 GL	23-26	269,70
90	27-30	389,76
125	31-36	476,76
150	37-39	631,62
170	40-42	776,04
225	43-48	1.146,66
280	49-54	1.593,85
360	55-60	2.110,62



AÇIK KAMALI SOKET		
MBL (Tons)	MM	€/AD
20 GL	11-13	128,76
25 GL	14-16	161,82
40 GL	17-19	220,98
55	20-22	325,38
75	23-26	424,56
90	27-29	622,92
110	30-32	944,82
125	34-36	1.129,26

Closed Spelter Sockets

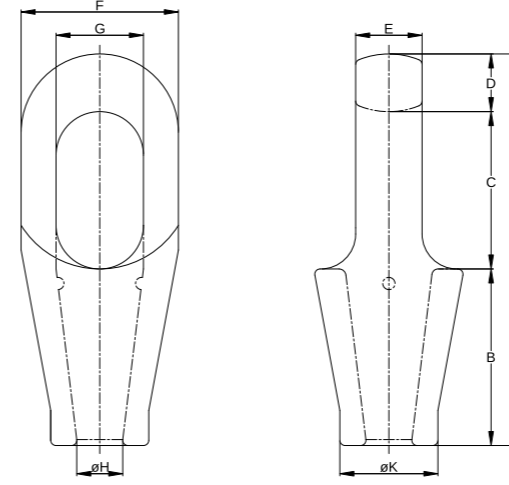

Open Spelter Sockets

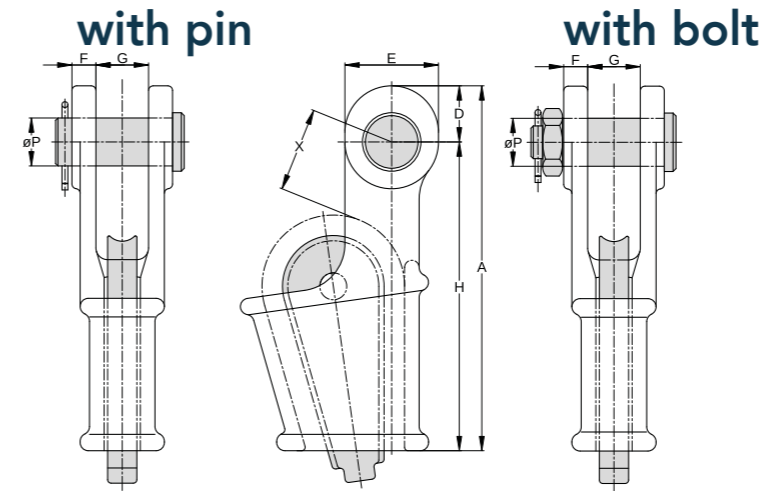
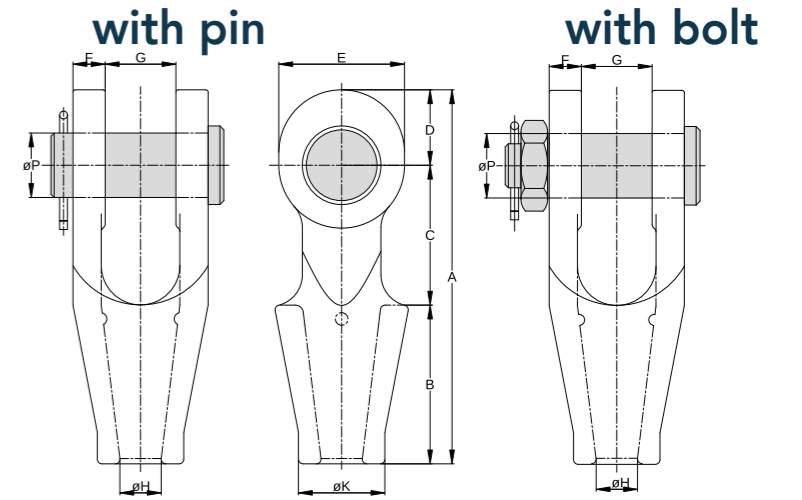

Open Wedge Sockets



KAPALI TİP SOKET

MBL (Tons)	MM (Çelik Halat)	€/AD
8 GL	6-7	168,64
12 GL	8-10	178,24
20 GL	11-13	211,53
25 GL	14-16	228,95
40 GL	18-19	253,57
55 GL	20-22	268,07
75	23-26	304,28
90	27-30	388,72
125	31-36	521,40
150	37-39	654,64
170	40-42	825,63
225	43-48	1.217,03
280	49-54	1.813,71
360	55-60	2.368,08
425	61-68	2.878,98
460	69-75	4.083,94
560	76-80	4.556,05
625	81-86	6.304,76
720	87-93	7.385,54
875	94-102	9.487,69
1200	108-115	15.070,29
1400	120-130	26.006,51



AÇIK TİP SOKET

MBL (Tons)	MM (Çelik Halat)	€/AD
8 GL	6-7	203,76
12 GL	8-10	230,36
20 GL	11-13	235,51
25 GL	14-16	244,30
40 GL	18-19	267,02
55	20-22	465,59
75	23-26	654,36
90	27-30	842,40
125	31-36	1.109,09
150	37-39	1.590,44
170	40-42	1.684,68
225	43-48	2.500,96
280	49-54	3.243,28
360	55-60	4.384,45
425	61-68	5.854,48
460	69-75	7.252,05
560	76-80	8.343,41
625	81-86	9.352,22
720	87-93	11.010,49
875	94-102	15.072,16
1200	108-115	25.426,43
1400	120-130	39.986,46



AÇIK KAMALI SOKET

MM	€/AD
11-13	223,40
14-16	269,85
18-19	374,46
20-22	513,34
24-26	680,40
27-29	878,97
30-32	1.507,01
34-36	1.830,80



SOKET YAPIŞTIRICISI

cc	€/AD
250	175,00
500	240,00
1000	394,00

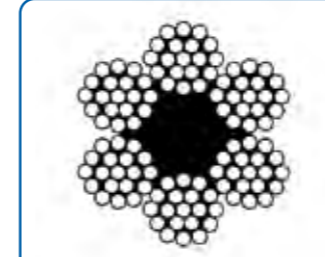

1X19 SERT KROM HALAT

MM	\$/MT
316 KALİTE	
2	0,580
3	1,172
4	2,010
5	3,139
6	4,354
8	7,740
10	12,083
12	17,404
14	23,693
16	30,940
19	39,162
20	48,343

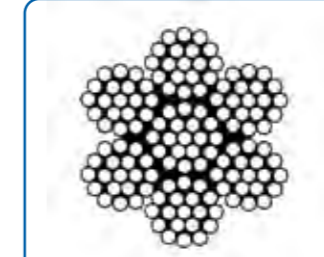

7X19 YUMUŞAK KROM HALAT

MM	\$/MT	\$/MT
316 KALİTE		304 KALİTE
2	0,774	0,591
3	1,215	0,946
4	1,871	1,280
5	2,645	1,830
6	3,677	2,494
8	6,192	4,085
10	9,492	6,203
12	13,663	8,933
14	18,600	12,158
16	24,284	15,880

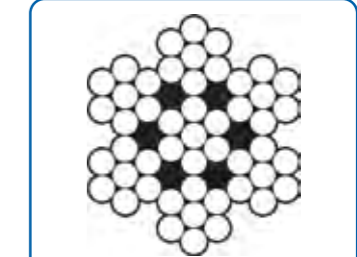

7X7 KROM HALAT

MM	\$/MT
304 KALİTE	
0,8	0,151
1	0,183
1,2	0,204
1,5	0,247
2	0,293
3	0,368



316 KALİTE PASLANMAZ MARİN ÜRÜNLERİ



ERKEK AYBOLT

MM	\$/AD
6	1,910
8	3,190
10	6,220
12	10,140
16	16,960



DIŞİ AYBOLT

MM	\$/AD
6	1,790
8	3,130
10	5,420
12	8,780
16	13,780
20	21,300



NORMAL ZİNCİR KİLİDİ UZUN TİP

MM	\$/AD
6	2,778
8	4,818
10	8,100
12	13,830



NORMAL ZİNCİR KİLİDİ

MM	\$/AD
4	1,292
5	1,387
6	1,625
8	3,066
10	5,071
12	8,042
16	18,768
20	35,232
22	48,637
25	64,816
28	105,316
32	172,334



OMEGA ZİNCİR KİLİDİ

MM	\$/AD
4	1,339
5	1,482
6	1,727
8	3,161
10	5,173
12	8,232
16	19,339
20	36,667
22	50,649
25	64,816

316 KALİTE PASLANMAZ MARİN ÜRÜNLERİ



DIN 766 ZİNCİR (316)

MM	\$/MT
2	2,732
3	6,233
4	11,625
5	17,766
6	28,383
8	47,996
10	77,565
12	110,193
16	217,935



ZİNCİR EK BAKLA

MM	\$/AD
6	4,500
8	5,100
10	6,774
12	11,904



LÜKS KARABİNA

MM	\$/AD
4	1,117
5	1,339
6	1,727
7	2,536
8	3,161
10	6,369
12	13,017



KLEMENS

MM	\$/AD
2	1,244
3	1,332
4	1,339
5	1,482
6	1,625
8	2,060
10	3,066
12	5,173
14	5,947
16	9,095
20	13,881
22	20,869



U-BOLT

MM	\$/AD
6x80	4,056
8x60	4,554
8x80	4,944
8x100	5,760
10x100	9,198
10x110	9,528
10x130	10,326
12x150	14,964



RADANSA

MM	\$/AD
3	0,238
4	0,265
5	0,381
6	0,510
8	0,673
10	1,292
12	1,869
14	3,446
16	4,215
20	8,422

316 KALİTE PASLANMAZ MARİN ÜRÜNLERİ

316 KALİTE PASLANMAZ MARİN ÜRÜNLERİ



ÇEKTİRME

MM	\$/AD
5	3,066
6	4,119
8	6,798
10	12,922
12	23,649
16	53,423



NORMAL LİFTİN

MM	\$/AD
5	5,369
6	7,011
8	11,506
10	18,632
12	31,779
14	37,256
16	72,325



KÖPRÜ

MM	\$/AD
4	0,546
5	0,660
6	1,033
8	1,700
10	4,420



FIRDÖNDÜ

MM	\$/AD
5	3,161
6	3,813
8	6,988
10	12,351
12	18,768
16	48,637



FIRDÖNDÜLÜ MANDAR KİLİDİ

MM	\$/AD
12	8,100
16	12,696
22	26,420



TEK KİLİT FIRDÖNDÜ

MM	\$/AD
6	4,600
8	9,050
10	17,220

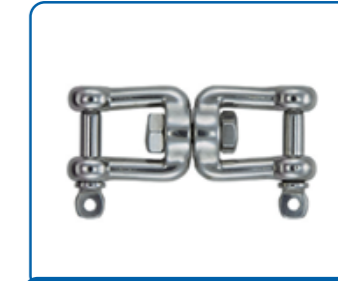

ÇİFT KİLİT FIRDÖNDÜ

MM	\$/AD
6	5,784
8	10,548
10	18,816



PASLANMAZ ÇELİK HALAT
TUTUCU CE BÉLGELİ

MM	\$/AD
8	75,993



ÇİFTLİ MAKARA

MM	\$/AD
25	12,827
32	15,607
50	29,488



TEKLİ MAKARA

MM	\$/AD
25	5,173
32	6,322
50	14,839

8 KOLLU POLİPROPİLEN HALATLAR



8 KOLLU TANKER HALATI

MM	KG/220MT	\$/KG
40	174	8,00
48	252	8,00
56	343	8,00
64	448	8,00
72	570	8,00
80	699	8,00

KUYRUK HALATI

MM	MBL (TON)	\$/ADET
64	68,7	198,70
72	86	251,40
80	105,8	311,46



8 KOLLU POLİPROPİLEN HALAT

MM	KG/220MT	\$/KG
40	159	7,00
48	229	7,00
56	312	7,00
64	407	7,00
72	515	7,00
80	638	7,00
88	772	7,00
96	918	7,00

Ürünlerimiz ALMAN LLYOD sertifikalıdır.

İP HALATLAR

FİYAT SORUNUZ



YERLİ SIZAL HALAT

MM	MIN. K.Y. MBL/KG	KG/220M
6	240,00	7,150
8	480,00	12,100
10	630,00	16,500
12	950,00	24,200
14	1280,00	31,900
16	1800,00	41,800
18	2130,00	53,900
20	2840,00	66,000
22	3400,00	78,100
24	4060,00	90,750
26	4720,00	105,500
28	5320,00	119,900
32	6860,00	138,600
36	8690,00	157,300



JÜT HALAT

MM	Ağırlık Gr/M
3	3,35
4	5,1
5	6,75
6	8,4
7	10
8	11,75
10	15,1
12	18,5
14	21,8
16	28,5
18	35,3
20	42
22	50
24	63
26	75,6

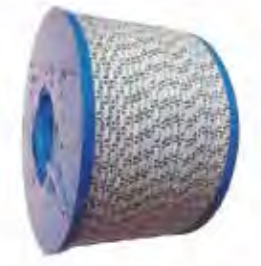

İSKOTA HALAT

MM	MIN. K.Y. MBL/KG	KG/220M
6	620,00	32
8	1090,00	46
10	1200,00	66
12	2400,00	98
14	3260,00	132
16	4200,00	181
18	5280,00	222
20	6600,00	305
22	7920,00	330
24	9410,00	383
26	11140,00	482
28	13380,00	515
30	15370,00	667
32	17470,00	684



YERLİ NAYLON HALAT PP

MM	MIN. K.Y. MBL/KG	KG/220M
6	400,00	3,400
8	700,00	6,100
10	1100,00	9,600
12	1720,00	13,800
14	2100,00	18,400
16	2700,00	24,100
18	3300,00	30,500
20	4000,00	37,600
22	4800,00	45,600
24	5600,00	54,200
26	6500,00	64,300
28	7500,00	74,500
32	9600,00	96,200
36	11900,00	122,500



TIGER HALAT - YÜZEN HALAT

MM	Min. Kopma Yüğü (Kg.)	Ağırlık
6	800	20
8	1040	30
10	1530	48
12	2170	69
14	2490	92
16	3700	120
18	4720	150
20	5690	190
22	6500	230
24	7920	270
26	9000	320
28	10500	370
32	13200	480



ACTIVEHAND® 2026 OCAK FİYAT LİSTESİ

ÜRÜN GÖRSEL	MODEL NO	RENK İPLİK/KAPLAMA	ÜRÜN TANIM	TEST DEĞER	KOLİ ADET	TAVSİYE EDİLEN PERAKENDE PEŞİN FİYAT USD (\$)
	PU-101	Siyah/Siyah Beyaz/Siyah Beyaz/Beyaz	%100 ÖRGÜ POLİÜRETAN AVUÇ İÇİ KAPL. POLYESTER ELDİVEN	3121X	240	1,41 1,46
	PU-215	siyah/siyah	%100 ÖRGÜ POLİÜRETAN AVUÇ İÇİ KAPL. POLYAMİD ELDİVEN	2011X	240	2,50
	NT-101	Siyah/Siyah Beyaz/Siyah Beyaz/Gri Kırmızı/Siyah	%100 ÖRGÜ NİTRİL AVUÇ İÇİ KAPL. POLYESTER ELDİVEN	3122X	240	1,81
	Süperfit	Siyah/Siyah Kırmızı/Siyah	%100 ÖRGÜ NİTRİL AVUÇ İÇİ KAPL. TIRTIKLI POLYESTER ELDİVEN	3121X	180	2,03
	XN-101	Siyah/Siyah Kırmızı/Siyah	%100 ÖRGÜ POLYESTER - NİTRİL KAPLAMA - 3/4 KAPLI	3122X	240	1,95
	FN-301 Comfort	Gri/Siyah	LİKRALI İPLİKLE ÖRÜLMÜŞ, AVUÇ İÇİ KAPLAMA, KÖPÜK NİTRİL KAPLI ELDİVEN	3121X	180	3,65
	FN-301 Ultraflex	Kırçillı Gri/Siyah	LİKRALI İPLİKLE ÖRÜLMÜŞ, AVUÇ İÇİ KAPLAMA, KÖPÜK NİTRİL KAPLI ELDİVEN	4121X	180	3,30
	SF-412	Kırçillı gri/Siyah	LİKRALI İPLİKLE ÖRÜLMÜŞ, AVUÇ İÇİ KAPLAMA, SANDY FINISH KÖPÜK NİTRİL KAPLI ELDİVEN	4X21A	120	3,49
	SF-512	Gri / Siyah	LİKRALI İPLİKLE ÖRÜLMÜŞ, AVUÇ İÇİ KAPLAMA, SANDY FINNISH KÖPÜK NİTRİL KAPLI ELDİVEN	4X31A	120	3,76

ACTIVEHAND® 2026 OCAK FİYAT LİSTESİ

ÜRÜN GÖRSEL	MODEL NO	RENK İPLİK/KAPLAMA	ÜRÜN TANIM	TEST DEĞER	KOLİ ADET	TAVSİYE EDİLEN PERAKENDE PEŞİN FİYAT USD (\$)
	PU-541	Gri/Siyah	YÜKSEK PERFORMANSLI POLİETİLEN İPLE ÖRÜLMÜŞ PU KAPLI ELDİVEN	4X42B	180	6,22
	PU-641	Gri/Siyah	YÜKSEK PERFORMANSLI POLİETİLEN İPLE ÖRÜLMÜŞ PU KAPLI ELDİVEN	4X42C	180	6,35
	PU-741	Melanj yeşil/Siyah	YÜKSEK PERFORMANSLI POLİETİLEN İPLE ÖRÜLMÜŞ AVUÇ İÇİ PU KAPLI ELDİVEN	4X44D	60	7,43
	PU-15111	Turuncu/Siyah	YÜKSEK PERFORMANSLI POLİETİLEN İPLE ÖRÜLMÜŞ PU KAPLI ELDİVEN	3X41B	60	6,62
	PU-15121	Yeşil/Siyah	YÜKSEK PERFORMANSLI POLİETİLEN İPLE ÖRÜLMÜŞ PU KAPLI ELDİVEN	4X42C	60	6,89
	PU-15131	Gri/Siyah	YÜKSEK PERFORMANSLI POLİETİLEN İPLE ÖRÜLMÜŞ PU KAPLI ELDİVEN	3X43D	60	
	PU-18111	Mavi/Siyah	YÜKSEK PERFORMANSLI POLİETİLEN İPLE ÖRÜLMÜŞ PU KAPLI ELDİVEN	3X41B	60	6,76
	PU-18121	Lacivert/Siyah	YÜKSEK PERFORMANSLI POLİETİLEN İPLE ÖRÜLMÜŞ PU KAPLI ELDİVEN	3X42C	60	7,03
	PU-18131	Gri/Siyah	YÜKSEK PERFORMANSLI POLİETİLEN İPLE ÖRÜLMÜŞ PU KAPLI ELDİVEN	3X43D	60	7,30
	PU-15241	Sarı/Siyah	ARAMİD VE NYLON SAPNDEX İPLE ÖRÜLMÜŞ PU KAPLI ELDİVEN	4X31E X1XXX	60	10,13

ACTIVEHAND® 2026 OCAK FİYAT LİSTESİ

ÜRÜN GÖRSEL	MODEL NO	RENK İPLİK/KAPLAMA	ÜRÜN TANIM	TEST DEĞER	KOLİ ADET	TAVSİYE EDİLEN PERAKENDE PEŞİN FİYAT USD (\$)
	NT-541	Gri/Siyah	YÜKSEK PERFORMANSLI POLİETİLEN İPLE ÖRÜLMÜŞ KÖPÜK NİTRİL KAPLI ELDİVEN	4X43A	60	6,35
	NT-641	Gri/Siyah	YÜKSEK PERFORMANSLI POLİETİLEN İPLE ÖRÜLMÜŞ KÖPÜK NİTRİL KAPLI ELDİVEN	3X42C	60	6,49
	NT-543	Gri/Siyah	YÜKSEK PERFORMANSLI POLİETİLEN İPLE ÖRÜLMÜŞ KÖPÜK NİTRİL KAPLI ELDİVEN	4X43B	60	
	XF-641	Gri/Siyah	YÜKSEK PERFORMANSLI POLİETİLEN İPLE ÖRÜLMÜŞ KÖPÜK NİTRİL KAPLI ELDİVEN	3X42C	60	7,03
	CRX-741	Gri/ Siyah	CRİNCLE LATEKS KAPLAMA POLİÜRETAN KAPLI KESİLMEMEYE DİRENÇLİ ELDİVEN	3X43D	120	8,92
	SF-814	Yeşil/ Siyah	SANDY FİNİŞ KÖPÜK KESİLMEMEYE DİRENÇLİ ELDİVEN	4X44D	120	7,97
	FCH-201	Açık Mavi/-	GIDA TEMASINA UYGUN, YÜKSEK PERFORMANSLI POLİETİLEN İLE ÖRÜLMÜŞ KESİLMEMEYE DİRENÇLİ ELDİVEN	2X43D	100	7,43
	XF-741	Yeşil/Siyah	YÜKSEK PERFORMANSLI POLİETİLEN İPLE ÖRÜLMÜŞ ¾ KÖPÜK NİTRİL KAPLI ELDİVEN	4X44D	60	8,11





ACTIVEHAND® 2026 OCAK FİYAT LİSTESİ

ÜRÜN GÖRSEL	MODEL NO	RENK İPLİK/KAPLAMA	ÜRÜN TANIM	TEST DEĞER	KOLİ ADET	TAVSİYE EDİLEN PERAKENDE PEŞİN FİYAT USD (\$)
	SF-434	Kırçılı gri/Siyah	LİKRALI İPLİKLE ÖRÜLMÜŞ, ¾ SANDY FİNİŞ KÖPÜK NİTRİL KAPLI ELDİVEN	4X21A	120	3,76
	SF-534	Gri/Siyah	LİKRALI İPLİKLE ÖRÜLMÜŞ, ¾ SANDY FİNİŞ KÖPÜK NİTRİL KAPLI ELDİVEN	4X31A	120	4,03
	SF-234D	Mavi/Siyah	LİKRALI İPLİKLE ÖRÜLMÜŞ, TAM NİTRİL KAPLAMA ÜZERİNE SANDY FİNİŞ KÖPÜK NİTRİL KAPLAMALI DOUBLE NİTRİL ELDİVEN	4121A	120	4,73
	SF-244D	Mavi/Siyah	LİKRALI İPLİKLE ÖRÜLMÜŞ, TAM NİTRİL KAPLAMA ÜZERİNE SANDY FİNİŞ KÖPÜK NİTRİL KAPLAMALI DOUBLE NİTRİL ELDİVEN	4121A	120	5,13
	FN-244D	Mavi/siyah	POLYESTER ASTAR ÜZERİNE ÇİFT KATLI NİTRİL KAPLAMALI ELDİVEN	4121X	120	3,5
	FLX-134	Mavi/Sarı	KÖPÜK DOĞAL LATEKS KAPLAMA	4X44D	240	2,30
	NT-741	Yeşil/ Siyah	YÜKSEK PERFORMANSLI POLİETİLEN İPLİKLE ÖRÜLMÜŞ AVUÇ İÇİ KÖPÜK NİTRİL KAPLI İŞ ELDİVENİ	4X43D	60	7,57
	FLX-614	Gri/Siyah	SPANDEX ÖRGÜ ASTAR ÜZERİNE KÖPÜK LATEKS KAPLAMA ELDİVEN	3141X	180	2,43
	CRX-101	Yeşil/Sarı	CRİNCLE LATEKS KAPLAMA	3X43X	180	2,70
	NF-101	Siyah/Siyah Beyaz/Sarı	POLYESTER ASTAR ÜZERİNE TAM NİTRİL KAPLAMALI ELDİVEN	3121X	240	2,57

ACTIVEHAND® 2026 OCAK FİYAT LİSTESİ

ÜRÜN GÖRSEL	MODEL NO	RENK İPLİK/KAPLAMA	ÜRÜN TANIM	TEST DEĞER	KOLİ ADET	TAVSİYE EDİLEN PERAKENDE PEŞİN FİYAT USD (\$)
	K-17	Yeşil	KİMYASALLARA KARŞI DAYANIKLI NİTRİL ELDİVEN	4102X	144	Fiyat Sorunuz
	SLV-15	Gri/-	YÜKSEK PERFORMANSLI POLİETİLEN İPLİK İLE ÖRÜLMÜŞ, KESİLMEME DİRENÇLİ 15 CM KOLLUK	4X4XC	100	Fiyat Sorunuz
	SLV-35	Gri/-	YÜKSEK PERFORMANSLI POLİETİLEN İPLİK İLE ÖRÜLMÜŞ, KESİLMEME DİRENÇLİ 35 CM KOLLUK	4X4XC	100	7,30
	SLV-45	Gri/-	YÜKSEK PERFORMANSLI POLİETİLEN İPLİK İLE ÖRÜLMÜŞ, KESİLMEME DİRENÇLİ 45 CM KOLLUK	4X4XC	100	8,11
	SLV-135	SARI/YEŞİL	C KESİLME DİRENÇLİ ISI SERTİFİKALI 35CM KOLLUK	1X2XC X1XXX	100	8,11
	SLV-145	Sarı/Yeşil	C KESİLME DİRENÇLİ ISI SERTİFİKALI 45CM KOLLUK	1X2XC X1XXX	100	8,65
	AC-01	İnterlog pamuk/nitril	PAMUK NİTRİL ELDİVEN	2121X	288	Fiyat sorunuz
	AC-02	İnterlog pamuk/nitril	PAMUK NİTRİL KAPLAMA	3121X	288	Fiyat sorunuz
	AC-02 PLUS	İnterlog pamuk/nitril	PAMUK NİTRİL KAPLAMA	3121X	288	Fiyat sorunuz

ACTIVEHAND® 2026 OCAK FİYAT LİSTESİ

ÜRÜN GÖRSEL	MODEL NO	RENK İPLİK/KAPLAMA	ÜRÜN TANIM	TEST DEĞER	KOLİ ADET	TAVSİYE EDİLEN PERAKENDE PEŞİN FİYAT USD (\$)
	AC-06 NANOTECH	Penye pamuk/ nitril	NANOTEKNOLOJİ NİTRİL KAPLAMA	4121X	240	Fiyat sorunuz
	AC-06 NANOTECH LACİVERT	Penye pamuk/ nitril	NANOTEKNOLOJİ NİTRİL KAPLAMA	4121X	240	Fiyat sorunuz
	CRX 201	Sarı/Yeşil	DOĞAL LATEKS KAPLAMA	3X43X	80	1,95
	SF-834	Mavi/ Siyah	LİKRALI İPLİKLE ÖRÜLMÜŞ, ¾ SANDY FINİŞ KÖPÜK NİTRİL KAPLI ELDİVEN	4X44D	120	8,65

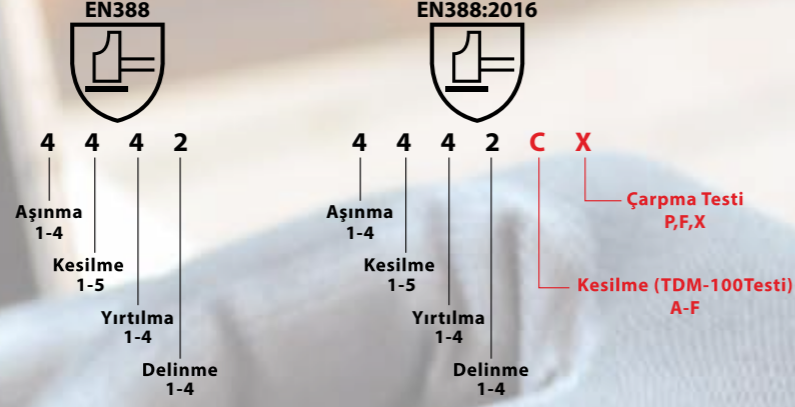

PERFORMANS DÜZEYİ	1	2	3	4	5
Aşınma Direnci	100	500	2000	8000	-
Kesilme Direnci	1,2	2,5	5	10	20
Yırtılma Direnci	10	25	50	75	-
Delinme Direnci	20	60	100	150	-

PERFORMANS DÜZEYİ	A	B	C	D	E	F
Kesilme Direnci (TDM-100 Testi)	2	5	10	15	22	30
Çarpma Direnci	P- Başarılı F- Başarısız X- Test edilmedi					

EL BOYUTU	(A) EL ÇEVRESİ (mm)	(B) EL UZUNLUĞU (mm)
6	152	160
7	178	171
8	203	182
9	229	192
10	254	204
11	279	215

BEDEN	UYGUN	MİNİMUM UZUNLUK
6	El Boyutu 6	220
7	El Boyutu 7	230
8	El Boyutu 8	240
9	El Boyutu 9	250
10	El Boyutu 10	260
11	El Boyutu 11	270

EN420

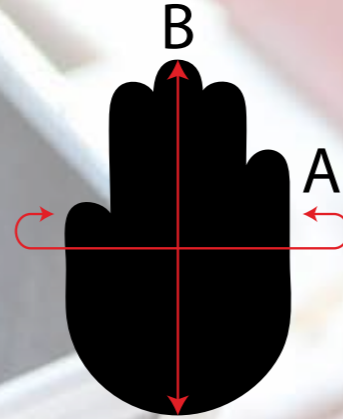

ERA YATAY KATLANIR (DUCK SERİSİ) SOLUNUM MASKELERİ

Ürün Kodu	Koruma Sınıfı	Ürün Özelliği	Model	Ambalaj Şekli	Kutu İçi Adeti	Koli İçi Adeti	Koli Ölçüsü	Koli Ağırlık	Birim	Fiyat Sorunuz
1100	FFP1 NR	Ventilsiz	Katlanır Serisi	Çoklu Ambalaj	25 Adet	500 Adet	60x38x30	5.75 kg	Adet	
1110 V	FFP1 NR	Ventilli	Katlanır Serisi	Çoklu Ambalaj	25 Adet	400 Adet	60x38x30	6.00 kg	Adet	
1200	FFP2 NR D	Ventilsiz	Katlanır Serisi	Çoklu Ambalaj	25 Adet	500 Adet	60x38x30	5.75 kg	Adet	
1210 V	FFP2 NR D	Ventilli	Katlanır Serisi	Çoklu Ambalaj	25 Adet	400 Adet	60x38x30	6.00 kg	Adet	
1300	FFP3 NR D	Ventilsiz	Katlanır Serisi	Çoklu Ambalaj	25 Adet	500 Adet	60x38x30	5.75 kg	Adet	
1310 V	FFP3 NR D	Ventilli	Katlanır Serisi	Çoklu Ambalaj	25 Adet	400 Adet	60x38x30	6.00 kg	Adet	
1300	FFP3 NR D	Ventilsiz	Katlanır Serisi	Tekli Ambalaj	30 Adet	300 Adet	46x53x32	6.75 kg	Adet	
1310 V	FFP3 NR D	Ventilli	Katlanır Serisi	Tekli Ambalaj	30 Adet	300 Adet	46x53x32	7.00 kg	Adet	

ERA KONİK SERİ SOLUNUM MASKELERİ

Ürün Kodu	Koruma Sınıfı	Ürün Özelliği	Model	Ambalaj Şekli	Kutu İçi Adeti	Koli İçi Adeti	Koli Ölçüsü	Koli Ağırlık	Birim	Fiyat Sorunuz
6100	FFP1 NR D	Ventilsiz	Konik Serisi	Çoklu Ambalaj	20 Adet	360 Adet	42x42x51	5.25 kg	Adet	
6110 V	FFP1 NR D	Ventilli	Konik Serisi	Çoklu Ambalaj	15 Adet	270 Adet	42x42x51	5.50 kg	Adet	
6200	FFP2 NR D	Ventilsiz	Konik Serisi	Çoklu Ambalaj	20 Adet	360 Adet	42x42x51	5.25 kg	Adet	
6210 V	FFP2 NR D	Ventilli	Konik Serisi	Çoklu Ambalaj	15 Adet	270 Adet	42x42x51	5.50 kg	Adet	

ERA DIKEY KATLAIR (C SERİSİ) SOLUNUM MASKELERİ

Ürün Kodu	Koruma Sınıfı	Ürün Özelliği	Model	Ambalaj Şekli	Kutu İçi Adeti	Koli İçi Adeti	Koli Ölçüsü	Koli Ağırlık	Birim	Fiyat Sorunuz
4100	FFP1 NR D	Ventilsiz	C Serisi	Tekli Ambalaj	25 Adet	450 Adet	72x52x27	7.90 kg	Adet	
4110 V	FFP1 NR D	Ventilli	C Serisi	Tekli Ambalaj	15 Adet	270 Adet	72x52x27	6.50 kg	Adet	
4200	FFP2 NR D	Ventilsiz	C Serisi	Tekli Ambalaj	25 Adet	450 Adet	72x52x27	7.90 kg	Adet	
4210 V	FFP2 NR D	Ventilli	C Serisi	Tekli Ambalaj	15 Adet	270 Adet	72x52x27	6.50 kg	Adet	
4300	FFP3 NR D	Ventilsiz	C Serisi	Tekli Ambalaj	25 Adet	450 Adet	72x52x27	7.90 kg	Adet	
4310 V	FFP3 NR D	Ventilli	C Serisi	Tekli Ambalaj	15 Adet	270 Adet	72x52x27	6.50 kg	Adet	

ERA N95 SOLUNUM MASKELERİ (KULAK ARKASI LASTİKLİ KN TİP)

Ürün Kodu	Koruma Sınıfı	Ürün Özelliği	Model	Ambalaj Şekli	Kutu İçi Adeti	Koli İçi Adeti	Koli Ölçüsü	Koli Ağırlık	Birim	Fiyat Sorunuz
C200	FFP2 NR D	Ventilsiz	C Serisi	Tekli Ambalaj	10 Adet	1200 Adet	61x54x39	13 kg	Adet	

ERA AKTİF KARBON SERİSİ SOLUNUM MASKELERİ (Kaynak Dumani ,Koku ve Toza Uygun)

Ürün Kodu	Koruma Sınıfı	Ürün Özelliği	Model	Ambalaj Şekli	Kutu İçi Adeti	Koli İçi Adeti	Koli Ölçüsü	Koli Ağırlık	Birim	Fiyat Sorunuz
5110 AC V	FFP1 NR D	Ventilli	C Serisi	Tekli Ambalaj	15 Adet	270 Adet	52x73x26,5	7.5 kg	Adet	
5200 AC	FFP2 NR D	Ventilsiz	C Serisi	Tekli Ambalaj	25 Adet	450 Adet	52x73x26,5	8.2 kg	Adet	
5210 AC V	FFP2 NR D	Ventilli	C Serisi	Tekli Ambalaj	15 Adet	270 Adet	52x73x26,5	7.5 kg	Adet	
7110 AC V	FFP2 NR D	Ventilli	Profesyonel Serisi	Çoklu Ambalaj	10 Adet	120 Adet	44x45,5x45	4.65 kg	Adet	
7200 AC	FFP2 NR D	Ventilsiz	Profesyonel Serisi	Çoklu Ambalaj	10 Adet	120 Adet	44x45,5x45	4.30 kg	Adet	
7210 AC V	FFP2 NR D	Ventilli	Profesyonel Serisi	Çoklu Ambalaj	10 Adet	120 Adet	44x45,5x45	4.65 kg	Adet	
7300 AC	FFP3 NR D	Ventilsiz	Profesyonel Serisi	Çoklu Ambalaj	10 Adet	120 Adet	44x45,5x45	4.30 kg	Adet	
7310 AC V	FFP3 NR D	Ventilli	Profesyonel Serisi	Çoklu Ambalaj	10 Adet	120 Adet	44x45,5x45	4.65 kg	Adet	
8810 AC V	FFP1 NR D	Ventilli	Eraflex Serisi	Çoklu Ambalaj	10 Adet	150 Adet	51x71x29	7.5 kg	Adet	
8820 AC V	FFP2 NR D	Ventilli	Eraflex Serisi	Çoklu Ambalaj	10 Adet	150 Adet	51x71x29	7.5 kg	Adet	
8820 AC V	FFP2 NR D	Ventilli (Tekrar Kullanılabilir)	Eraflex Serisi	Çoklu Ambalaj	10 Adet	150 Adet	51x71x29	7.75 kg	Adet	
8800 AC	FFP2 NR D	Ventilsiz	Eraflex Serisi	Çoklu Ambalaj	10 Adet	150 Adet	51x71x29	7 kg	Adet	
8803 AC	FFP3 NR D	Ventilsiz	Eraflex Serisi	Çoklu Ambalaj	10 Adet	150 Adet	51x71x29	7 kg	Adet	
8830 AC V	FFP3 NR D	Ventilli	Eraflex Serisi	Çoklu Ambalaj	10 Adet	150 Adet	51x71x29	7.50 kg	Adet	
9910 AC V	FFP1 NR D	Ventilli	Profesyonel Serisi	Tekli Ambalaj	15 Adet	360 Adet	52x55,5x42	10.60 kg	Adet	
9920 AC V	FFP2 NR D	Ventilli	Profesyonel Serisi	Tekli Ambalaj	15 Adet	360 Adet	52x55,5x42	10.60 kg	Adet	
9900 AC V	FFP3 NR D	Ventilsiz	Profesyonel Serisi	Tekli Ambalaj	20 Adet	480 Adet	52x55,5x42	10 kg	Adet	
9930 AC V	FFP3 NR D	Ventilli	Profesyonel Serisi	Tekli Ambalaj	15 Adet	360 Adet	52x55,5x42	10.60 kg	Adet	

ERA PROFESYONEL SERİSİ SOLUNUM MASKELERİ (4 NOKTA BAĞLANTILI)

Ürün Kodu	Koruma Sınıfı	Ürün Özelliği	Model	Ambalaj Şekli	Kutu İçi Adeti	Koli İçi Adeti	Koli Ölçüsü	Koli Ağırlık	Birim	Fiyat Sorunuz
6320 V	FFP2 NR D	Ventilli	Profesyonel Serisi	Çoklu Ambalaj	10 Adet	120 Adet	44x45,5x45	4.75 kg	Adet	
6300	FFP3 NR D	Ventilsiz	Profesyonel Serisi	Çoklu Ambalaj	10 Adet	120 Adet	44x45,5x45	4.50 kg	Adet	
6330 V	FFP3 NR D	Ventilli	Profesyonel Serisi	Çoklu Ambalaj	10 Adet	120 Adet	44x45,5x45	4.75 kg	Adet	

ERA PREMIUM SERİSİ SOLUNUM MASKELERİ (3 PANELLİ)



Ürün Kodu	Koruma Sınıfı	Ürün Özelliği	Model	Ambalaj Şekli	Kutu İçi Adeti	Koli İçi Adeti	Koli Ölçüsü	Koli Ağırlık	Birim	Fiyat Sorunuz
9100	FFP1 NR D	Ventilsiz	Premium Serisi	Tekli Ambalaj	20 Adet	480 Adet	52x55,5x42	9.70 kg	Adet	
9110 V	FFP1 NR D	Ventilli	Premium Serisi	Tekli Ambalaj	15 Adet	360 Adet	52x55,5x42	10.80 kg	Adet	
9200	FFP2 NR D	Ventilsiz	Premium Serisi	Tekli Ambalaj	20 Adet	480 Adet	52x55,5x42	9.70 kg	Adet	
9210 V	FFP2 NR D	Ventilli	Premium Serisi	Tekli Ambalaj	15 Adet	360 Adet	52x55,5x42	10.80 kg	Adet	
9300	FFP3 NR D	Ventilsiz	Premium Serisi	Tekli Ambalaj	20 Adet	480 Adet	52x55,5x42	9.70 kg	Adet	
9310 V	FFP3 NR D	Ventilli	Premium Serisi	Tekli Ambalaj	15 Adet	360 Adet	52x55,5x42	10.80 kg	Adet	

ERAFLEX SERİSİ SOLUNUM MASKELERİ (FILELİ MODEL)

Ürün Kodu	Koruma Sınıfı	Ürün Özelliği	Model	Ambalaj Şekli	Kutu İçi Adeti	Koli İçi Adeti	Koli Ölçüsü	Koli Ağırlık	Birim	Fiyat Sorunuz
8100	FFP1 NR D	Ventilsiz	Eraflex Serisi	Çoklu Ambalaj	10 Adet	150 Adet	51x71x29	6 kg	Adet	
8110 V	FFP1 NR D	Ventilli	Eraflex Serisi	Çoklu Ambalaj	10 Adet	150 Adet	51x71x29	7.50 kg	Adet	
8200	FFP2 NR D	Ventilsiz	Eraflex Serisi	Çoklu Ambalaj	10 Adet	150 Adet	51x71x29	6 kg	Adet	
8210 V	FFP2 NR D	Ventilli	Eraflex Serisi	Çoklu Ambalaj	10 Adet	150 Adet	51x71x29	7.50 kg	Adet	
8210 V	FFP2 NR D	Ventilli (Tekrar Kullanılabilir)	Eraflex Serisi	Çoklu Ambalaj	10 Adet	150 Adet	51x71x29	7.75 kg	Adet	
8300	FFP3 NR D	Ventilsiz	Eraflex Serisi	Çoklu Ambalaj	10 Adet	150 Adet	51x71x29	6 kg	Adet	
8310 V	FFP3 NR D	Ventilli	Eraflex Serisi	Çoklu Ambalaj	10 Adet	150 Adet	51x71x29	7.50 kg	Adet	

TOZ MASKELERİ						
Görsel	Ürün Kodu	Ürün Bilgisi	Fiyat Sorunuz	Ambalaj Şekli		
				Birim	Kutu İç Adet	Koli İç Adet
	3951080	Dräger X-plore 1710 FFP1 D (Ventilsiz)		Adet	20	360
	3951081	Dräger X-plore 1710 V FFP1 D (Ventilli)		Adet	10	270
	3951083	Dräger X-plore 1720 FFP2 D		Adet	20	360
	3951084	Dräger X-plore 1720 V FFP2 D (Ventilli)		Adet	10	270
	3951085	Dräger X-plore 1720 V Odour FFP2 D (Ventilli)		Adet	10	270
	3951088	Dräger X-plore 1730 V FFP3 D (Ventilli)		Adet	10	270
	3951910	Dräger X-plore 1910 FFP1 D, M/L		Adet	20	200
	3951911	Dräger X-plore 1910 FFP1 D, S		Adet	20	200
	3951915	Dräger X-plore 1910 V FFP1 D, M/L		Adet	10	100
	3951916	Dräger X-plore 1910 V FFP1 D, S		Adet	10	100
	3951920	Dräger X-plore 1920 FFP2 D, M/L		Adet	20	200
	3951921	Dräger X-plore 1920 FFP2 D, S		Adet	20	200
	3951925	Dräger X-plore 1920 V FFP2 D, M/L		Adet	10	100
	3951926	Dräger X-plore 1920 V FFP2 D, S		Adet	10	100
	3951930	Dräger X-plore 1930 FFP3 D, M/L		Adet	20	200
	3951931	Dräger X-plore 1930 FFP3 D, S		Adet	20	200
	3951935	Dräger X-plore 1930 V FFP3 D, M/L		Adet	5	100
	3951936	Dräger X-plore 1930 V FFP3 D, S		Adet	5	100

TOZ MASKELERİ						
Görsel	Ürün Kodu	Ürün Bilgisi	Fiyat Sorunuz	Ambalaj Şekli		
				Birim	Kutu İç Adet	Koli İç Adet
	3951211	Dräger X-plore 1310 FFP1 D		Adet	20	240
	3951212	Dräger X-plore 1310 V FFP1 D (Ventilli)		Adet	10	180
	3951213	Dräger X-plore 1320 FFP2 D		Adet	20	240
	3951214	Dräger X-plore 1320 V FFP2 D (Ventilli)		Adet	20	180
	3951216	Dräger X-plore 1330 V FFP3 D (Ventilli) S/M		Adet	5	60
	3951217	Dräger X-plore 1330 V FFP3 D (Ventilli) M/L		Adet	5	60
	3951215	Dräger X-plore 1320 V Odour FFP2 D (Ventilli Odour)		Adet	10	180
	3951218	Dräger X-plore 1330 V Odour FFP3 D (Ventilli Odour)		Adet	5	60
	3951511	Dräger X-plore 1510 FFP1 D		Adet		200
	3951516	Dräger X-plore 1510 V FFP1 D (Ventilli)		Adet		200
	3951523	Dräger X-plore 1520 FFP2 D		Adet		200
	3951528	Dräger X-plore 1520 V FFP2 D (Ventilli)		Adet		200

YARIM & TAM YÜZ MASKELEİ						
Görsel	Ürün Kodu	Ürün Bilgisi	Fiyat Sorunuz	Ambalaj Şekli		
				Birim	Kutu İç Adet	Koli İç Adet
	R55875	Dräger X-plore 4740 S/M Yarım Yüz Maskesi Tek Filtreli		Adet	1	
	R55874	Dräger X-plore 4740 L/XL Yarım Yüz Maskesi Tek Filtreli		Adet	1	
	R55331	Dräger X-Plore 3300, S Yarım Yüz Maskesi Çift Filtreli		Adet	1	16
	R55330	Dräger X-Plore 3300, M Yarım Yüz Maskesi Çift Filtreli		Adet	1	16
	R55332	Dräger X-Plore 3300, L Yarım Yüz Maskesi Çift Filtreli		Adet	1	16
	R55351	Dräger X-Plore 3500, S Yarım Yüz Maskesi Çift Filtreli		Adet	1	16
	R55350	Dräger X-Plore 3500, M Yarım Yüz Maskesi Çift Filtreli		Adet	1	16
	R55352	Dräger X-Plore 3500, L Yarım Yüz Maskesi Çift Filtreli		Adet	1	16
	R55270	Dräger X-Plore 5500 - EPDM / PC Çift Filtreli		Adet	1	
	R55800	Dräger X-plore 6300 EPDM/PMMA Tam Yüz Maskesi Pleksiglas Vizörlü, Tek filtreli		Adet	1	
	R55795	Dräger X-plore 6530 EPDM/PC Tek Filtreli		Adet	1	
	R55810	Dräger X-plore 6530 - EPDM / Triplex Vizörlü Tek Filtreli		Adet	1	
	R55850	Dräger X-plore 6570 - Silikon/ Triplex Vizörlü Tek Filtreli		Adet	1	
	R55790	Dräger X-plore 6570 - Silikon / PC Vizörlü Tek Filtreli		Adet	1	

YARIM & TAM YÜZ MASKELEİ YEDEK PARÇA						
Görsel	Ürün Kodu	Ürün Bilgisi	Fiyat Sorunuz	Ambalaj Şekli		
				Birim	Kutu İç Adet	Koli İç Adet
	R55218	Dräger X-plore 3500 Baş Bandı Lastiği (Yedek Parça)		Adet	1	
	R55224	Dräger X-plore 3500 Baş Bandı (Yedek Parça)		Adet	1	
	R26279	Dräger X-plore 5500/6300 Baş Bandı (Yedek Parça)		Adet	1	
	R50833	Dräger X-plore 5500 Vizör (Yedek Parça)		Adet	1	
	R26989	Dräger X-plore 5500 Triplex Vizör (Yedek Parça)		Adet	1	
	R26470	Dräger X-plore 6300 Vizör (Yedek Parça)		Adet	1	
	4055092	Dräger X-plore Vizör Koruyucu Film (25 adet)		Paket	1	

FİLTRELER						
Görsel	Ürün Kodu	Ürün Bilgisi	Fiyat Sorunuz	Ambalaj Şekli		
				Birim	Kutu İç Adet	Koli İç Adet
	6738001	P1 Partikül Filtre Pedi Bayonet		Çift	10	
	6738002	P2 Partikül Filtre Pedi Bayonet		Çift	10	
	6738011	Dräger X-plore® P3 Filtre Bayonet		Çift	11	
	6738353	Dräger X-plore® Pure P2 Bayonet		Çift	10	
	6738354	Dräger X-plore® Pure P3 Bayonet		Çift	10	
	6738391	Dräger X-plore® Pure Odour P3 Bayonet		Çift	10	
	6738872	A1 Filtre Bayonet		Çift	10	
	6738873	A2 Filtre Bayonet		Çift	10	
	6738778	A1B1E1 Filtre Bayonet		Çift	10	
	6738816	A1B1E1K1 Filtre Bayonet		Çift	10	
	6738775	A2B2 Filtre Bayonet		Çift	9	
	6738874	A1-P3 Filtre D Bayonet		Çift	7	
	6738875	A2-P3 Filtre D Bayonet		Çift	7	
	6738817	A1B1E1K1Hg-P3 Filtre D Bayonet		Çift	7	
	6738776	A2B2-P3 Filtre D Bayonet		Çift	6	
	6738819	A2B2E2K2Hg-P3 Filtre D Bayonet		Çift	5	
	6738356	Pure-Adapter Bayonet		Çift	5	
	6738038	Ped Kapagi (P1 ve P2 pedler için) Bayonet		Çift	6	
	6738039	Ped Yuvası (P1 ve P2 pedler için) Bayonet		Çift	6	
		6738855	A2 Filtre RD40		Adet	1
6738779		A2B2 Filtre RD40		Adet	1	50
6738856		K2 Filtre RD40		Adet	1	50
6738863		AX Filtre RD40		Adet	1	50
6738802		A2B2E2K1 Filtre RD40		Adet	1	50
6738804		A2B2E2K2 Filtre RD40		Adet	1	50
6732974		P3 Toz Filtresi RD40		Adet	1	25
6738783		A2B2-P3 Filtre D RD40		Adet	1	50
6738862		AX-P3 Filtre D RD40		Adet	1	50
6738803		A2B2E2K1-P2 Filtre D RD40		Adet	1	50
6738797	A2B2E2K2 HG P3 Filtre D RD40		Adet	1	50	
6738801	A1B2E2K1 HG CO NO P3 Filtre D RD40		Adet	1	50	

GÖZ KORUYUCU						
Görsel	Ürün Kodu	Ürün Bilgisi	Fiyat Sorunuz	Ambalaj Şekli		
				Birim	Kutu İç Adet	Koli İç Adet
	R58247	Dräger X-pect 8110		Adet	10	
	R58248	Dräger X-pect 8120		Adet	10	
	R58957	Dräger X-pect 8240		Adet	10	300
	R58249	Dräger X-pect 8310		Adet	10	300
	R58268	Dräger X-pect 8320		Adet	10	300
	R58269	Dräger X-pect 8321		Adet	10	300
	R58267	Dräger X-pect 8330		Adet	10	300
	371740	Dräger X-pect 2400		Adet	10	300
	3717411	Dräger X-pect 2420		Adet	10	300
	3717310	Dräger X-pect 4200 Şeffaf		Adet	10	300
	3717311	Dräger X-pect 4200 Siyah		Adet	10	300
	3717320	Dräger X-pect 4400 Şeffaf		Adet	10	300
	3717321	Dräger X-pect 4400 Siyah		Adet	10	300
	3717341	Dräger X-pect 4800 Siyah		Adet	10	300
	3717350	Dräger X-pect 4900 Sand		Adet	10	300
	3717351	Dräger X-pect 4900 Oliv		Adet	10	300

VÜCUT KORUYUCU						
Görsel	Ürün Kodu	Ürün Bilgisi	Fiyat Sorunuz	Ambalaj Şekli		
				Birim	Kutu İç Adet	Koli İç Adet
	R63547	Draeger SPC 4400 S Sarı (CPM)		Adet	1	25
	R63548	Draeger SPC 4400 M Sarı (CPM)		Adet	1	25
	R63549	Draeger SPC 4400 L Sarı (CPM)		Adet	1	25
	R63550	Draeger SPC 4400 XL Sarı (CPM)		Adet	1	25
	R63551	Draeger SPC 4400 2XL Sarı (CPM)		Adet	1	25
	R63552	Draeger SPC 4400 3XL Sarı (CPM)		Adet	1	25

KAFKA KORUMA				
STOK KODU	ÜRÜN ADI VE AÇIKLAMASI	AMBALAJ ŞEKLİ	GÖRSEL	Fiyat Sorunuz
SC 600	BBU SAFETY CNG 600 ABS HAVA KANALLI VİDA ÇARK AYARLI TEKSTİL İÇLİKLİ İŞ GÜVENLİĞİ BARETİ CE EN 397:2012+A1, -30, MM	HER BİRİ LDPE POŞETTE 1 KOLİ 20 ADET BOX SIZE: 42*30*75CM NET: 7,65KG GROSS: 8,65KG		
SC 700	BBU SAFETY CNG 700 ABS HAVA KANALLI VİDA ÇARK AYARLI TEKSTİL İÇLİKLİ İŞ GÜVENLİĞİ BARETİ CE EN 397:2012+A1, -30, MM, LD	BELGE AŞAMASINDA		
SC 500	BBU SAFETY ABS VİDA ÇARK AYARLI TEKSTİL İÇLİKLİ ELEKTRİKÇİ BARETİ CE EN 397:2012+A1 EN 50365 CLASS 0 1000V, -30, MM	HER BİRİ LDPE POŞETTE 1 KOLİ 20 ADET BOX SIZE: 42*30*75CM NET: 7,61KG GROSS: 8,59KG		
SC 500M	BBU SAFETY SC CNG 500 ABS VİDA ÇARK AYARLI TEKSTİL İÇLİKLİ MADENCİ BARETİ CE EN 397:2012+A1 EN 50365 CLASS 0 1000V, -30, MM	HER BİRİ LDPE POŞETTE 1 KOLİ 20 ADET BOX SIZE: 42*30*75CM NET: 7,85KG GROSS: 8,84KG		
SC 500P	BBU SAFETY CNG 500 HDPE VİDA ÇARK AYARLI TEKSTİL İÇLİKLİ ELEKTRİKÇİ BARETİ EN 397:2012+A1 EN 50365 CLASS 0 1000V ANSI Z.89.1 CLASS E 20.000V - 30.000V, -30, MM	HER BİRİ LDPE POŞETTE 1 KOLİ 20 ADET BOX SIZE: 42*30*75CM NET: 6,96KG GROSS: 7,95KG		
SC 6000	BBU SAFETY SP 6000 ABS VİDA ÇARK AYARLI TEKSTİL İÇLİKLİ İŞ GÜVENLİĞİ BARETİ 397:2012+A1 EN 50365 CLASS 0 1000V, -30	HER BİRİ LDPE POŞETTE 1 KOLİ 20 ADET BOX SIZE: 42*30*75CM NET: 6,96KG GROSS: 7,95KG		
SC 7000	BBU SAFETY SP 6001 VİDA ÇARK AYARLI TEKSTİL İÇLİKLİ YÜKSEK ISI BARETİ EN 397:2012+ A1 -30, MM, LD, +150	HER BİRİ LDPE POŞETTE 1 KOLİ 20 ADET BOX SIZE: 42*30*75CM		
SC 7000F	BBU SAFETY SP 6001 VİDA ÇARK AYARLI TEKSTİL İÇLİKLİ ORMANCI BARETİ EN 397:2012+A1 -30, MM, LD, +150	HER BİRİ LDPE POŞETTE 1 KOLİ 20 ADET BOX SIZE: 42*30*75CM		
SC 7000RF	BBU SAFETY SP 6000 SERİSİ REFLEKTÖR SETİ			

SC 200	BBU SAFETY SP 200 HDPE (PUSH & PULL) SİSTEM ENSEDEDEN AYARLI PLASTİK İÇLİKLİ HAVA KANALLI BARET CE EN 397:2012+A1	HER BİRİ PE POŞETTE 1 KOLİ 20 ADET BOX SIZE: 74*30*42CM NET: 7,40KG GROSS: 8,38KG		
SC 200R	BBU SAFETY SP200 HDPE VİDA ÇARK AYARLI PLASTİK İÇLİKLİ HAVA KANALLI BARET CE EN 397:2012+A1	HER BİRİ LDPE POŞETTE 1 KOLİ 20 ADET BOX SIZE: 42*30*75CM NET: 7,41KG GROSS: 8,39KG		
SC 200T	BBU SAFETY SP 200 HDPE VİDA ÇARK AYARLI TEKSTİL İÇLİKLİ HAVA KANALLI İŞ GÜVENLİĞİ BARETİ CE EN 397:2012+A1	HER BİRİ LDPE POŞETTE 1 KOLİ 20 ADET BOX SIZE: 42*30*75CM NET: 6,87KG GROSS: 7,86KG		
SC 300	BBU SAFETY SP 300 HDPE VİDA ÇARK AYARLI TEKSTİL İÇLİKLİ ELEKTRİKÇİ BARETİ EN 397:2012+A1 EN 50365 CLASS 0 1000V ANSI Z.89.1 CLASS E 20.000V - 30.000V, MM	HER BİRİ LDPE POŞETTE 1 KOLİ 20 ADET BOX SIZE: 42*30*75CM NET: 6,87KG GROSS: 7,86KG		
SC 3000	BBU SAFETY SP 3000 HDPE MANUEL (PRESS&PULL) AYARLI PLASTİK İÇLİKLİ İŞ GÜVENLİĞİ BARETİ CE EN 397:2012+A1	HER BİRİ LDPE POŞETTE 1 KOLİ 20 ADET BOX SIZE: 42*30*75CM NET: 6,75KG GROSS: 7,75KG		
SC 3000R	BBU SAFETY SP 3001 / SP 3000R HDPE VİDA ÇARK AYARLI PLASTİK İÇLİKLİ İŞ GÜVENLİĞİ BARETİ CE EN 397:2012+A1	HER BİRİ LDPE POŞETTE 1 KOLİ 20 ADET BOX SIZE: 42*30*75CM NET: 6,75KG GROSS: 7,75KG		
SC 5000	BBU SAFETY SP 5000 FULL BRIM VİDA ÇARK AYARLI TEKSTİL İÇLİKLİ BARET CE EN 397:2012+A1 EN 50365 CLASS 0 1000V -30	HER BİRİ LDPE POŞETTE 1 KOLİ 20 ADET BOX SIZE: 54*63*42,50 CM NET: 8,40KG GROSS: 10,00KG		
SC 9000	BBU SAFETY SP 9000 HAVA KANALLI YÜKSEKTE ÇALIŞMA BARETİ EN 397:2012 + A1 , -30, MM, LD EN 12492	BELGE AŞAMASINDA		
SC 9001	BBU SAFETY SP 9001 YÜKSEKTE ÇALIŞMA ELEKTRİKÇİ BARETİ EN 397:2012+A1 EN 50365 CLASS 0 1000V -30, MM, LD	HER BİRİ 1 KUTU 1 KOLİ 10 ADET BOX SIZE: 72*23*56 CM NET: 4,30KG GROSS: 6,70KG		
SC 800	BBU SAFETY SP 800 VİZÖRLÜ ELEKTRİKÇİ BARETİ EN 397:2012+A1 EN 50365 CLASS 0 1000V -30, MM, LD ANSI Z.89.1 CLASS E 20.000V - 30.000V EN 166, GS ET 29, ASTM F 2178	BELGE AŞAMASINDA		

SC 100	BBU SAFETY SP 100 DARBE EMİCİ ŞAPKA EN 812	BELGE AŞAMASINDA		
SC 3000I	PLASTİK İÇLİK KOMPLE SET (PRESS&PULL) SİSTEM SP 3000 MODELE UYGUNDUR			
SC 3000IR	PLASTİK İÇLİK KOMPLE SET (VİDA ÇARK AYARLI) SİSTEM SP 3001 / 3000R MODELE UYGUNDUR			
SC 200I	PLASTİK İÇLİK KOMPLE SET (PUSH & PULL) SİSTEM SP 200, SP 300, SP 5000 MODELLER İÇİN			
SC 200IR	PLASTİK İÇLİK KOMPLE SET VİDA ÇARK AYARLI SİSTEM SP 200, SP 300, SP 5000 MODELLER İÇİN			
SC 500I	TEKSTİL İÇLİK KOMPLE SET CNG 600, CNG 500, SP 200, SP 300, SP 5000 MODELLER İÇİN			
SC SP	6. NOKTADAN BAĞLANTI APARATI SP 200 TEKSTİL, SP 300, SP5000 İÇİN			
SC SPN	6. NOKTADAN BAĞLANTI APARATI SP 6000 SERİSİ İÇİN			
SC CS00	BBU SAFETY EKONOMİK AYARLANABİLİR ÇENE BAĞI SP 3000, SP 3000R BARETLER İÇİN			
SC CS01	ÇENE BAĞI 2 BAĞLANTILI	100 ADET PE POŞETTE		

SC CS02	ÇENE BAĞI 4 BAĞLANTILI	50 ADET PE POŞETTE		
SC CS03	ÇENE BAĞI 3 NOKTADAN BAĞLANTILI SP 200, SP 300, SP 5000 SERİSİ İÇİN	50 ADET PE POŞETTE		
SC CS04	ÇENE BAĞI 4 NOKTADAN BAĞLANTILI SP 6000 VE SP 9001 BARET İÇİN	50 ADET PE POŞETTE		
SC CS05	ÇENE BAĞI 4 NOKTADAN BAĞLANTILI MAGNETLİ TOKA , EN 397 + EN 12492 YE GÖRE AYARLANABİLİR ÖZELLİKTE	1 ADET PE POŞETTE		
SC SW01	SUNİ DERİ YEDEK TER BANDI CNG 500, CNG 600, SP 200, SP 300 VE SP 5000 MODELLER İÇİN			
SC SW02	BARET YEDEK TER BANDI SP 3000 İÇİN			
SC SW03	BARET YEDEK TER BANDI SP 6000 İÇİN			
YÜZ KORUMA				
FS 500	BARETE MONTE BRAKET TAKIMI CE EN 166 B	HER BİRİ LDPE POŞETTE 1 KOLİ 50 ADET BOX SIZE: 42*30*75CM NET: 4,56KG GROSS: 5,56KG		
FS 501	1MM POLİKARBONAT YEDEK YÜZ VİZÖRÜ CE EN 166 1 B	100 ADET BİR KOLİ BOX SIZE: 21*17*39CM NET: 10,00KG GROSS: 10,25KG		
FS 700	BARETE MONTE ELEKTRİKÇİ YÜZ SİPERLİĞİ SETİ CE EN 166 B T CE EN 166 BT 8 9 GS-ET-29 ASTM F2178	BELGE AŞAMASINDA		

FS 701	2MM POLİKARBONAT ELEKTRİKÇİ YEDEK YÜZ VİZÖRÜ CE EN 166 B T CE EN 166 BT 8 9 GS-ET-29 ASTM F2178	BELGE AŞAMASINDA		
KULAK KORUMA				
EP 500	QUAD® KULAK TIKACI CE EN 352-2 22dB	50 ÇİFT 1 KUTU - 20 KUTU 1 KOLİ - 1 KOLİ 1000 ÇİFT BOX SIZE: 72*40*30 CM NET: 13,00 KG GROSS: 13,50KG		
EP 600	TRIAD® KULAK TIKACI CE EN 352-2 25,7dB	50 ÇİFT 1 KUTU - 20 KUTU 1 KOLİ - 1 KOLİ 1000 ÇİFT BOX SIZE: 72*40*30 CM NET: 13,00 KG GROSS: 13,50KG		
EP 700	TRINITY® KULAK TIKACI CE EN 352-2 26dB	50 ÇİFT 1 KUTU - 20 KUTU 1 KOLİ - 1 KOLİ 1000 ÇİFT BOX SIZE: 72*40*30 CM NET: 13,00 KG GROSS: 13,50KG		
EP 700MD	TRINITY® KULAK TIKACI METAL DETECTABLE CE EN 352-2 26dB	50 ÇİFT 1 KUTU - 20 KUTU 1 KOLİ - 1 KOLİ 1000 ÇİFT BOX SIZE: 72*40*30 CM NET: 13,00 KG GROSS: 13,50KG		
HB 500	BBU SAFETY HB 500 KULAKLIK	BELGE AŞAMASINDA		
HB 501	BBU SAFETY HB 501 KULAKLIK	BELGE AŞAMASINDA		
HB 502	BBU SAFETY HB 502 KULAKLIK	BELGE AŞAMASINDA		
HM 500	BBU SAFETY HM 500 BARETE MONTE KULAKLIK	BELGE AŞAMASINDA		
HM 501	BBU SAFETY HM 501 BARETE MONTE KULAKLIK	BELGE AŞAMASINDA		







HM 502	BBU SAFETY HM 502 BARETE MONTE KULAKLIK	BELGE AŞAMASINDA		
ERGONOMİ ÜRÜNLERİ				
BP 3115	EL ALETLERİ GÜVENLİK BİLEK HALATI	HER BİRİ ASKILI PE POŞETTE		
BP 3116	EL ALETLERİ GÜVENLİK HALATI	HER BİRİ ASKILI PE POŞETTE		
SC SB01	BBU SAFETY KATLANIR BARET GÜNEŞ SİPERLİĞİ			
BP 0140	BBU SAFETY REFLEKTÖRLÜ BİLEKLİK			
ETİKETLEME / KİLİTLEME				
SL 7700	BBU SAFETY İSKELE GÜVENLİK ETİKETİ TAŞIYICISI ABS	20 ADET BİR KUTU		
SL 7701	İSKELE GÜVENLİK ETİKETİ MONTAJ VE DENETİM KAYDI YEŞİL RENK TR/ENG			
SL 7702	TAMAMLANMAMIŞ İSKELE SARI RENK ENG			
SL 7703	TAMAMLANMIŞ İSKELE YEŞİL RENK ENG			
SL 7705	İSKELE GÜVENLİK ETİKETİ MONTAJ VE DENETİM KAYDI YEŞİL / SARI RENK TR			







SL 7706	İSKELE GÜVENLİK ETİKETİ MONTAJ VE DENETİM KAYDI YEŞİL / SARI İNGİLİZCE			
SL 38SS	BBU SAFETY GÜVENLİK KİLİDİ ÇELİK KANCA 38MM	HER BİRİ KUTUSUNDA KOLİSİ 20 ADET		
SL 38PS	BBU SAFETY GÜVENLİK KİLİDİ PLASTİK KANCA 38MM	HER BİRİ KUTUSUNDA KOLİSİ 20 ADET		
SL 74SS	BBU SAFETY GÜVENLİK KİLİDİ ÇELİK KANCA 74MM	HER BİRİ KUTUSUNDA KOLİSİ 20 ADET		
SL 74PS	BBU SAFETY GÜVENLİK KİLİDİ PLASTİK KANCA 74MM	HER BİRİ KUTUSUNDA KOLİSİ 20 ADET		
SL MK01	BBU SAFETY MASTER KEY SİSTEM (HER KİLİT İÇİN İLAVE 1 EURO)			
SL MK02	BBU SAFETY MASTER ANAHTAR (HER BİR ANAHTAR İÇİN)			
MCB 01	BBU SAFETY ÜNİVERSAL MİNYATÜR DEVRE KESİCİ KİLİT	20 ADET 1 PAKET		
MCB 11	DIŞA AÇILAN DAR ELEKTRİK SİGORTA KİLİDİ ≤ 12mm	10 ADET 1 PAKET		
MCB 12	DIŞA AÇILAN GENİŞ ELEKTRİK SİGORTA KİLİDİ ≤ 20mm	10 ADET 1 PAKET		







MCB 13	İÇE AÇILAN ELEKTRİK SİGORTA KİLİDİ ≤ 12mm	10 ADET 1 PAKET		
PH 01	BBU SAFETY PLASTİK KİLİT ÇOKLAYICI	10 ADET 1 PAKET		
PH 02	BBU SAFETY PLASTİK KİLİT ÇOKLAYICI 6MM	40 ADET 1 KUTU		
PH 03	BBU SAFETY PLASTİK KİLİT ÇOKLAYICI 3MM	45 ADET 1 KUTU		
SL BL01	BBU SAFETY BUTON KİLİDİ SETİ ÇAP: 38mm-30mm-22mm	HER BİR SET BİR PE POŞETTE		
SH 025	BBU SAFETY SH 025 ÇELİK KİLİT ÇOKLAYICI	HER BİRİ PE POŞETTE		
SH 040	BBU SAFETY SH 040 ÇELİK KİLİT ÇOKLAYICI	HER BİRİ PE POŞETTE		
WL 01	KABLOLU KİLİT ÇOKLAYICI 4mm 2 METRE			
WL 02	KABLOLU KİLİT ÇOKLAYICI 4mm 3 METRE			
GV 01	BBU SAFETY SÜRGÜLÜ VANA KİLİDİ (GATEVALVE) 25-64mm	40 ADET 1 KOLİ		







GV 02	BBU SAFETY SÜRGÜLÜ VANA KİLİDİ (GATEVALVE) 64-127mm	12 ADET 1 KOLİ		
GV 03	BBU SÜRGÜLÜ VANA KİLİDİ (GATE VALVE) 127-165mm	28 ADET 1 KOLİ		
SL BV01	BBU SAFETY AYARLANABİLİR KÜRESEL VANA KİLİDİ 13 mm(1/2") ila 64mm(2 1/2")			
SL L01EN	STANDART KİLİTLEME ETİKETİ ÇİFT YÖN 7,5CM X 13,5CM İNGİLİZCE			
SL L01TR	STANDART KİLİTLEME ETİKETİ ÇİFT YÖN 7,5CM X 13,5CM TÜRKÇE/İNGİLİZCE			
SL LS007	BBU SAFETY KİLİT ASMA APARATI 7 KİLİT METAL			
SL LS0014	BBU SAFETY KİLİT ASMA APARATI 14 KİLİT METAL			
SL LS0021	BBU SAFETY KİLİT ASMA APARATI 21 KİLİT METAL			
SL LS0028	BBU SAFETY KİLİT ASMA APARATI 28 KİLİT METAL			
SL LS01	BBU SAFETY 14 KİLİT KAPASİTELİ KİLİTLEME İSTASYONU METAL			





SL LS02	BBU SAFETY 28 KİLİT KAPASİTELİ KİLİTLEME İSTASYONU METAL			
SL GLB1	BBU SAFETY GRUP KİLİTLEME KUTUSU METAL			
İLK YARDIM				
FAK 0001	BBU SAFETY DUVARA MONTE İLK YARDIM SETİ	FIYAT SORUNUZ		
FAK 0010	BBU SAFETY DUVARA MONTE İLK YARDIM SETİ EKONOMİK MODEL	FIYAT SORUNUZ		
ATIK YÖNETİMİ				
SCN 400	BBU SAFETY HAZNELİ PALET 4 VARİL KAPASİTELİ, 2 YÖNLÜ FORKLİFT YA DA TRANSPALET İLE TAŞINABİLİR, 1330X 1330MM, 330lt KAPASİTE, BOŞ AĞIRLIK 30KG, 1250KG TAŞIMA KAPASİTESİ			
SCN 26801	BBU SAFETY DIŞ MEKAN KÜLLÜĞÜ			

Ürün Görsel	Art No	Ürün Açıklaması	Fiyat Sorunuz
	9192180	PHEOS GUARD CLEAR SV EXTR. BLACK/GREY	
	9192225	PHEOS CLEAR SV EXC. BLACK/GREEN	
	9192270	PHEOS ONE CLEAR SV SAPPH. BLACK	
	9192285	PHEOS GREY SV EXC. BLACK/GRAU	
	9192370	PHEOS ONE SV EXCELL. CLEAR BLACK	
	9193280	SPORTSTYLE GR. SV EXTR. BLACK/WHITE	
	9193376	SPORTSTYLE SV EXTR. CL. BLK/BLUE/BLK	

Ürün Görsel	Art No	Ürün Açıklaması	Fiyat Sorunuz
	9198237	PHEOS CX2 GREY SV EXCELL WHITE/BLACK	
	9198256	PHEOS CX2 CLEAR SV EXCELL BLK/LIGHT BLUE	
	9198257	PHEOS CX2 CLEAR SV EXC. BLUE/GREY	
	9301714	ULTRAVISION CA CLEAR AF, GREY/TRANSP.	
	9302245	ULTRASONIC CLEAR SV EXC. ORANGE/GREY	
	9302285	ULTRASONIC CL. SV EXC. GREY/BLACK	





Ürün Görsel	Art No	Ürün Açıklaması	Fiyat Sorunuz
	9970002	CLEANING STATION WITH ACCESSORIES	
	9971000	CLEANING TISSUES FOR MODEL 9970	
	9972100	CLEANING SOLUT. FLUID 0,5 L FOR 9970 NEW	
	65021	LOW SHOE 6502/1 BLACK/ORANGE S3 PU W10	
	65022	LOW SHOE 6502/2 BLACK/ORANGE S3 PU W11	
	65023	LOW SHOE 6502/3 BLACK/ORANGE S3 PU W12	
	65024	LOW SHOE 6502/4 BLACK/ORANGE S3 PU W14	



Ürün Görsel	Art No	Ürün Açıklaması	Fiyat Sorunuz
	65031	BOOT 6503/1 BLACK/ORANGE S3 PU W10	
	65032	BOOT 6503/2 BLACK/ORANGE S3 PU W11	
	65033	BOOT 6503/3 BLACK/ORANGE S3 PU W12	
	65034	BOOT 6503/4 BLACK/ORANGE S3 PU W14	
	85141	LOW SHOE 8514/1 BLACK/LİME S1P PU W10	
	85142	LOW SHOE 8514/2 BLACK/LİME S1P PU W11	
	85143	LOW SHOE 8514/3 BLACK/LİME S1P PU W12	

Ürün Görsel	Art No	Ürün Açıklaması	Fiyat Sorunuz
	85161	LOW SHOE 8516/1 BLACK/RED S3 PU W10	
	85162	LOW SHOE 8516/2 BLACK/RED S3 PU W11	
	85163	LOW SHOE 8516/3 BLACK/RED S3 PU W12	
	85420	SANDAL 8542/0 S1 PU W14	
	85427	SANDAL 8542/7 S1 PU W10	
	85428	SANDAL 8542/8 S1 PU W11	

Ürün Görsel	Art No	Ürün Açıklaması	Fiyat Sorunuz
	85430	LOW SHOE 8543/0 PER. S1 PU W14	
	85437	LOW SHOE 8543/7 PER. S1 PU W10	
	85438	LOW SHOE 8543/8 PER. S1 PU W11	
	85439	LOW SHOE 8543/9 PER. S1 PU W12	
	85440	LOW SHOE 8544/0 PU W14	

Ürün Görsel	Art No	Ürün Açıklaması	Fiyat Sorunuz
	85447	LOW SHOE 8544/7 BL/SILV/LİME S2 PU W10	
	85448	LOW SHOE 8544/8 BL/SILV/LİME S2 PU W11	
	85450	BOOT 8545/0 BL/SILV/LİME S2 PU W14	
	85457	BOOT 8545/7 BL/SILV/LİME S2 PU W10	
	85458	BOOT 8545/8 BL/SILV/LİME S2 PU W11	

Ürün Görsel	Art No	Ürün Açıklaması	Fiyat Sorunuz
	2111202	WHISPER, CORDED, WITH BOX, 50 PAIRS	
	2112000	UVEX DISPENSER	
	2112003	X-FIT EARPL., 200X1 PAIRS BULK P., REFİL	
	60049	PHYNOMIC ALLROUND	
	60060	PHYNOMIC WET	







Ürün Görsel	Art No	Ürün Açıklaması	Fiyat Sorunuz
	60061	PHYNOMIC WET PLUS	
	60062	UVEX PHYNOMIC PRO	
	60080	PHYNOMIC C3	
	60081	UVEX PHYNOMIC C5	
	60122	UVEX PROFASTRONG NF33	
	60208	UVEX PROFİ ERGO XG 20	

Ürün Görsel	Art No	Ürün Açıklaması	Fiyat Sorunuz
	60491	C500 SLEEVE	
	60492	C500 WET	
	60494	C500 FOAM	
	60558	UVEX PROFİ ERGO XG 20A	
	60596	UVEX U-FIT	
	60972	U-CHEM 3200	





 KAPTIV SERİSİ	B1005C K-RUSH S1P HRO SRC NUMARA: 36 / 48	 KAPTIV SERİSİ	B1005B K-TREK S1P HRO SRC NUMARA: 36 / 48
 KAPTIV SERİSİ	B1004C K-SPEED S1P HRO SRC NUMARA: 36 / 48	 KAPTIV SERİSİ	B1004B K-MOVE S1P HRO SRC NUMARA: 36 / 48
 KAPTIV SERİSİ	B1006A K-BALANCE S1P HRO SRC NUMARA: 36 / 48	 KAPTIV SERİSİ	B1000B K-ROAD S3 HRO SRC NUMARA: 36 / 48
 LINE I 4	B1210 I-ROBOX S3 CI ESD SRC NUMARA: 35 / 48	 KAPTIV SERİSİ	B1002A K-POP S1P SRC NUMARA: 36-43
 LINE I 4	B1217 I-TOOL S1P ESD SRC NUMARA: 35 / 48	 LINE I 4	B1205A I BIT S1P ESD SRC NUMARA: 35 / 48
 CLASSIC PLUS	B0886 BE - STYLE S1P ESD SRC NUMARA: 36 / 50	 RECORD SERİSİ	B0643 DARTS S1P SRC ESD NUMARA: 34 / 49

 CLASSIC PLUS	B0887N BE UNIFORM S3 HRO SRC NUMARA: 39 / 48	 CLASSIC PLUS	B0887 BE-STRONG S3 HRO CI HI SRC NUMARA: 39 / 48
 ELEKTRİGE DİRENÇLİ	B0874 BE-JOY S3 SRC NUMARA: 36 / 50	 CLASSIC PLUS	B0866 BE-BROWNY S3 CI SRC NUMARA: 36 / 50
 KAPTIV SERİSİ	B1001B K-ROAD TOP S3 HRO SRC NUMARA: 36 / 48	 LINE I 4	B1211 I-ROBOX TOP S3 CI ESD SRC NUMARA: 35 / 48
 SPECIAL SERİSİ	B0898S POWERFULL TOP S3 WR CI SRC NUMARA: 36 / 50	 SPECIAL SERİSİ	B0895S BE-DRY MID S3 HRO CI WR SRC NUMARA: 39 / 50
 CLASSIC PLUS	B0888 BE STRONG TOP S3 HRO CI HI SRC NUMARA: 39 / 48	 CLASSIC PLUS	B0888N BE UNIFORM S3 HRO CI SRC NUMARA: 39 / 48
 SPECIAL SERİSİ	B0880 SPARLE S3 HRO CI HI SRC NUMARA: 36 / 48	 CLASSIC PLUS	B0883 BE-BROWNY TOP S3 CI SRC NUMARA: 36 / 50
 FORTREX SERİSİ	B1601 T-REX MID S3S HRO CI HI LG FO SR NUMARA: 36 / 48	 FORTREX SERİSİ	B1601B T-WALL MID S3S HRO CI HI LG FO SR NUMARA: 36 / 48

 <p>NEW</p> <p>FORTREX SERİSİ</p>	<p>B1610A T-REX TOP S3S HRO CI HI LG FO SR NUMARA: 36 / 48</p>	 <p>NEW</p> <p>FORTREX SERİSİ</p>	<p>B1610B T-WALL TOP S3S HRO CI HI LG FO SR NUMARA: 36 / 48</p>
 <p>NEW</p> <p>FORTREX SERİSİ</p> <p>water proof</p>	<p>B1605 T-ROBUST S7S HRO CI HI LG FO SR NUMARA: 36 / 48</p>	 <p>NEW</p> <p>FORTREX SERİSİ</p> <p>water proof</p>	<p>B1603 T-FORT S3 WR CI HI HRO SRC NUMARA: 36 / 48</p>
 <p>NEW</p> <p>FORTREX SERİSİ</p> <p>water proof</p>	<p>B1613 T-ROBUST TOP S7S HRO CI HI LG FO SR NUMARA: 39 / 50</p>	 <p>CLASSIC PLUS</p>	<p>B0870B BE-EXTREME W S3 CI SRC NUMARA: 39 / 50</p>
 <p>CLASSIC PLUS</p>	<p>B0883C BE-GREY MID S3 CI SRC NUMARA: 36 / 50</p>		

ÜRÜNLER						
Görsel	Ürün Kodu	Ürün Bilgisi	Fiyat Sorunuz	Ambalaj Şekli		
				Birim	Kutu İç Adet	Koli İç Adet
		U-Power Arizona S3 SRC (STOKLAR DAHİLİNDE SATIŞI MEVCUTTUR)		ÇİFT	1	10
		U-Power Bjorn S3 SRC (STOKLAR DAHİLİNDE SATIŞI MEVCUTTUR)		ÇİFT	1	10
		U-Power Brezza S1P SRC		ÇİFT	1	10
		U-Power Bulls S3 HRO H1 SRC		ÇİFT	1	10
		U-Power Calgary S3 SRC		ÇİFT	1	10
		U-Power Class S2 SRC (STOKLAR DAHİLİNDE SATIŞI MEVCUTTUR)		ÇİFT	1	10

ÜRÜNLER						
Görsel	Ürün Kodu	Ürün Bilgisi	Fiyat Sorunuz	Ambalaj Şekli		
				Birim	Kutu İç Adet	Koli İç Adet
		U-Power Curtiss S1 SRC (STOKLAR DAHİLİNDE SATIŞI MEVCUTTUR)		ÇİFT	1	10
		U-Power Greenland S3 SRC		ÇİFT	1	10
		U-Power Nuvola (Nube) S1 SRC (STOKLAR DAHİLİNDE SATIŞI MEVCUTTUR)		ÇİFT	1	10
		U-Power Point S1P SRC		ÇİFT	1	10
		U-Power Quebec S3 SRC		ÇİFT	1	10

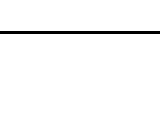
ÜRÜNLER						
Görsel	Ürün Kodu	Ürün Bilgisi	Fiyat Sorunuz	Ambalaj Şekli		
				Birim	Kutu İç Adet	Koli İç Adet
		U-Power Response Grip S2 SRC (STOKLAR DAHİLİNDE SATIŞI MEVCUTTUR)		ÇİFT	1	10
		U-Power Senna S1P SRC		ÇİFT	1	10
		U-Power Sprint ESD S1 SRC (STOKLAR DAHİLİNDE SATIŞI MEVCUTTUR)		ÇİFT	1	10
		U-Power Texas / Jena S3 SRC (STOKLAR DAHİLİNDE SATIŞI MEVCUTTUR)		ÇİFT	1	10
		U-Power Yukon S3 SRC (STOKLAR DAHİLİNDE SATIŞI MEVCUTTUR)		ÇİFT	1	10
		U-Power Miami (STOKLAR DAHİLİNDE SATIŞI MEVCUTTUR)		ÇİFT	1	10

ÜRÜNLER						
Görsel	Ürün Kodu	Ürün Bilgisi	Fiyat Sorunuz	Ambalaj Şekli		
				Birim	Kutu İç Adet	Koli İç Adet
U-GREEN						
Min teslim süresi 10-12 haftadır.		U-power Naturak UK ESD S2 CL SRC		ÇİFT	1	10
		U-Power Island UK ESD S3 CL SRC		ÇİFT	1	10
		U-Power Canyon UK ESD S1P SRC		ÇİFT	1	10
		U-Power Niagara UK ESD S3 CL SRC		ÇİFT	1	10
RED INDUSTRY						
Min teslim süresi 10-12 haftadır.		U-power Stoccolma ESD S3 CL SRC		ÇİFT	1	10
		U-power Lisbonna ESD S3 CL SRC		ÇİFT	1	10
		U-Power Oslo ESD S1P SRC		ÇİFT	1	10
		U-Power Mistral ESD S1P SRC		ÇİFT	1	10
		U-Power Helsinki UK ESD S3 CL SRC		ÇİFT	1	10
		U-Power Moska UK ESD S3 CL SRC		ÇİFT	1	10
GORETEX						
Min teslim süresi 10-12 haftadır.		U-power Drop GTX S3 HRO HI CL WR SRC		ÇİFT	1	10
		U-power Domination S3 WR CL SRC		ÇİFT	1	10
RED LEVE (390 Gr)						
Min teslim süresi 10-12 haftadır.		U-power Ben ESD S3 SRC		ÇİFT	1	10
		U-power Bruce ESD S1P SRC		ÇİFT	1	10
		U-power Tylor ESD S3 SRC		ÇİFT	1	10
		U-power Scott ESD S1P SRC		ÇİFT	1	10
		U-Power Liam ESD SRC Beyaz		ÇİFT	1	10

KAFA KORUMA ÜRÜNLERİ

GÜVENLİK GÖZLÜKLERİ VE YÜZ KORUMALARI

ASO2 ŞEFFAF		ASO2 FÜME		IRAYA ŞEFFAF		IRAYA SARI		IRAYA FÜME		LIPARI2 ŞEFFAF					
K N UV400		K N UV400		K N UV400		K N UV400		K N UV400		K N UV400					
Koli İçi 100	Kutu İçi 10	Koli İçi 100	Kutu İçi 10	Koli İçi 100	Kutu İçi 10	Koli İçi 100	Kutu İçi 10	Koli İçi 100	Kutu İçi 10	Koli İçi 100	Kutu İçi 10				
PREMIUM		PREMIUM		EVOLUTION		EVOLUTION		EVOLUTION		EVOLUTION					
ASO2IN		ASO2FU		IRAYAIN		IRAYAFU		IRAYAJA		LIPA2BLIN					
AM-AS-UV400-K-N GÖZLÜK POLİKARBONAT CAM POLİKARBONAT/TPR ÇERÇEVE EKSTRA KONFOR İÇİN TPR BURUN PEDİ KAYMAZ ESNEK SAPLAR GÖZLÜK İPİ PAKETE DAHİL 28 GR				AM- AS-UV400 POLİKARBONAT CAM GÖZLÜK EKSTRA KONFOR İÇİN TPR BURUN PEDİ KAYMAZ ESNEK SAPLAR 61 GR				AS-UV400 POLİKARBONAT CAM GÖZLÜK YANAL KORUMA AYARLANABİLİR SAPLAR 61 GR							
EN 166 1 FT KN / FT EN170 UV 2C-1.2 ANTIFOG		EN 166 1 FT KN / FT EN172 UV 5-2.5 ANTIFOG		EN 166 1 FT / FT EN170 UV 2C-1.2 ANTIFOG		EN 166 1 FT / FT EN170 UV 2C-1.2 ANTIFOG		EN 166 1 FT / FT EN172 UV 5-3.1 ANTIFOG		EN 166 1 FT / FT EN170:2002 UV 2C-1.2 ANTIFOG					
FUJI CLEAR		FUJI GRADIENT		PACAYA LYVIZ		PACAYA STRAP		PACAYA FÜME		PACAYA CLEAR					
K N UV400		K N UV400		K N UV400		K N UV400		K N UV400		K N UV400					
Koli İçi 100	Kutu İçi 10	Koli İçi 100	Kutu İçi 10	Koli İçi 100	Kutu İçi 10	Koli İçi 100	Kutu İçi 10	Koli İçi 100	Kutu İçi 10	Koli İçi 100	Kutu İçi 10				
PREMIUM		PREMIUM		PREMIUM		PREMIUM		PREMIUM		PREMIUM					
FUJI2NOIN		FUJI2NOOR		PACAYLVIN		PACAYSTIN		PACAYNOFU		PACAYBLIN					
AM (ŞEFFAF MODEL) – AS - UV400 POLİKARBONAT CAM EKSTRA KONFOR İÇİN TPR BURUN PEDİ KAYMAZ ESNEK SAPLAR 37 GR				AM-AS-UV400 POLİKARBONAT CAM - OLEOPHOBIC VE HYDROPHOBIC KAPLAMA 52 GR				AM-AS-UV400 POLİKARBONAT CAM BAŞ BANTLI 52 GR				AM-AS-UV400 POLİKARBONAT CAM KÖPÜK İÇ KAPLAMA 52 GR			
EN 166 1 FT / FT EN170 UV 2C-1.2 ANTIFOG		EN 166 1 FT / FT EN172 UV 5-1.4 : 5-1.7		EN 166 1 FT / FT EN170 UV 2C-1.2 ANTIFOG		EN 166 1 FT / FT EN170 UV 2C-1.2 ANTIFOG		EN 166 1 FT / FT EN172 UV 5-3.1 ANTIFOG		EN 166 1 FT / FT EN170 UV 2C-1.2 ANTIFOG					

KAFA KORUMA ÜRÜNLERİ

GÜVENLİK GÖZLÜKLERİ VE YÜZ KORUMALARI

VULCANO2 PLUS ŞEFFAF		VULCANO2 ŞEFFAF		VULCANO2 FÜME		FUEGO ŞEFFAF		HEKLA2 ŞEFFAF		EGON LIGHT MIRROR									
K N UV400		K N UV400		K N UV400		K N UV400		K N UV400		K N UV400									
Koli İçi 100	Kutu İçi 10	Koli İçi 100	Kutu İçi 10	Koli İçi 100	Kutu İçi 10	Koli İçi 100	Kutu İçi 10	Koli İçi 100	Kutu İçi 10	Koli İçi 100	Kutu İçi 10								
EVOLUTION		EVOLUTION		EVOLUTION		EVOLUTION		EVOLUTION		EVOLUTION									
VULC2PLIN		VULC2ORIN		VULC2NOFU		FUEGOARIN		HEKL2IN		EGONROLM									
AM-AS-UV400-K-N GÖZLÜK POLİKARBONAT CAM EĞİLEBİLİR VE AYARLANABİLİR SAPLAR 37 GR				AM-AS-UV400 GÖZLÜK POLİKARBONATCAM EĞİLEBİLİR VE AYARLANABİLİR SAPLAR TPE BURUN DESTEĞİ 37 GR				AM-AS-UV400 BARETE TAKILABİLİR GÖZLÜK POLİKARBONAT CAM TPE BURUN DESTEĞİ 34 GR				AS -UV400 GÖZLÜK ÜSTÜ GÖZLÜK POLİKARBONAT CAM 37 GR				AM-AS-UV400 AYNALI GÖZLÜK POLİKARBONAT CAM 34 GR			
EN 166 1 FT KN / FT EN170 UV 2C-1.2 ANTIFOG		EN 166 1 FT / FT EN170 UV 2C-1.2 ANTIFOG		EN 166 1 FT / FT EN172 UV 5-3.1 ANTIFOG		EN 166 1 FT / FT EN170 UV 2C-1.2 ANTIFOG		EN 166 1 FT / FT EN170 UV 2C-1.2 ANTIFOG		EN 166 1 FT / FT EN170 UV 2C-1.2		EN 166 1 FT / FT EN170 UV 2C-1.7							
EGON ŞEFFAF		EGON FÜME		BRAVA2 AB ŞEFFAF		BRAVA2 ŞEFFAF		BRAVA2 SARI		BRAVA2 FÜME									
K N UV400		K N UV400		K N UV400		K N UV400		K N UV400		K N UV400									
Koli İçi 100	Kutu İçi 10	Koli İçi 100	Kutu İçi 10	Koli İçi 100	Kutu İçi 10	Koli İçi 100	Kutu İçi 10	Koli İçi 100	Kutu İçi 10	Koli İçi 100	Kutu İçi 10								
EVOLUTION		EVOLUTION		ESSENTIAL		ESSENTIAL		ESSENTIAL		ESSENTIAL									
EGONGRIN		EGONGRFU		BRAV2INAB		BRAV2IN		BRAV2JA		BRAV2FU									
AM-AS-UV400 POLİKARBONAT CAMLI GÖZLÜK GENİŞ KORUMA ALANI VE YAN SİPERLER TPE BURUN PEDİ 34 GR				AM- AS-UV400 POLİKARBONAT CAM YAN KORUMA BUĞU ÖNLEYİCİ KAPLAMA 25 GR				AS-UV400 POLİKARBONAT CAMLI GÖZLÜK YAN KORUMA 25 GR											
EN 166 1 FT / FT EN170 UV 2C-1.2 ANTIFOG		EN 166 1 FT / FT EN172 UV 5-3.1 ANTIFOG		EN166 1 FT / FT EN170 UV 2C-1.2 ANTIFOG		EN 166 1 FT / FT EN170 UV 2C-1.2		EN 166 1 FT / FT EN170 UV 2C-1.2		EN 166 1 FT / FT EN172 UV 5-3.1									

KAFA KORUMA ÜRÜNLERİ

GÜVENLİK GÖZLÜKLERİ VE YÜZ KORUMALARI

KILIMANDJARO ŞEFFAF	KILIMANDJARO FÜME						
Koli İçi 100	Kutu İçi 10	Koli İçi 100	Kutu İçi 10				
ESSENTIAL	ESSENTIAL						
KILIMGRIN	KILIMNOFU100						
AS - UV400 YAN SİPERLİKLİ POLİKARBONAT GÖZLÜK 71 GR							
EN 166 1 FT / FT EN170 UV 2C-1.2	EN 166 1 FT / FT EN172 UV 5-3.1						
SAJAMA ŞEFFAF	GALERAS ŞEFFAF	GALERAS FÜME	TOBA3 T5 ŞEFFAF VE T5	LIPARI 2 T5			
Koli İçi 60	Paket 10	Koli İçi 60	Paket 10	Koli İçi 60	Paket 10	Koli İçi 100	Paket 10
PREMIUM SAJAMIN	EVOLUTION GALERVI	EVOLUTION GALERVF	EVOLUTION TOBA3T5	PREMIUM LIPA2T5			
POLİKARBONAT CAM TPE ÇERÇEVE NEOPREN BANT DOLAYLI HAVALANDIRMA - KİMYASAL DAYANIMLI NEOPREN BANT UV400- K-N 92 GR	PVC KORUMA GÖZLÜĞÜ POLİKARBONAT CAM DOLAYLIHAVALANDIRMA UV400-AM-AS 104 GR		UV400-AM-AS KALDIRILABİLİR SİPERLİKLİ KAYNAK GÖZLÜĞÜ. ŞEFFAF İÇ CAM. ŞEFFAF POLİKARBONAT GÜÇLENDİRMELİ 5. TON MİNERAL ÜST CAMI 157 GR	AM - AS - UV400 - KAYNAKÇI GÖZLÜK POLİKARBONAT CAM TPE BURUN PEDİ AYARLANABİLİR SAPLAR 61 GR			
EN 166 1 BTKN / 34 BT EN170 UV 2C-1.2 ANTIFOG	EN 166 1 BT / 34 BT ANTIFOG	EN 166 1 BT / 34 BT EN172 UV 5-3.1 ANTIFOG	EN 166 1 FTN / FT EN169 5 EN175 F ANTIFOG	EN 166 1 FT / FT EN169 UV 5 ANTIFOG			

KAFA KORUMA ÜRÜNLERİ

GÜVENLİK GÖZLÜKLERİ VE YÜZ KORUMALARI

VISOR HOLDER	VISOR PC ŞEFFAF	VISOR TORIC ŞEFFAF	VISORFLASH YEŞİL	BALBİ2 ŞEFFAF			
Koli İçi 20	Paket 1	Koli İçi 20	Paket 1	Koli İçi 20	Paket 1		
EVOLUTION VISHONO	EVOLUTION VISORPCIN	PREMIUM VISORTOIN	PREMIUM VISORF14	EVOLUTION BALB2IN			
QUARTZ VE DIAMOND BARETLER İÇİN SİPERLİK TUTUCU VISORPC, VISTOR TORIC VE VISOR FLASH SİPERLİKLER İÇİ UNIVERSAL 86 GR	2 ADET ŞEFFAF POLİKARBONAT VİZÖR KITI - BALBİ2 - VISOR HOLDERİÇİN- 39 X 20 CM 100 GR	ŞEFFAF POLİKARBONAT VİZÖR - VISOR HOLDER İLE KULLANILIR ELEKTRİK ARK KORUMA 178 GR	ELEKTRİK ARKI VE TERMAL RİSKE KARŞI POLİKARBONAT ENJEKSİYON SİPERLİK. DAHA İYİ IŞIK İLETİMİ İÇİN YEŞİL TON 237 GR	ÖN KORUMALI YÜZ SİPERİ + VISORPC VİZÖR : PLASTİK KENARLI ŞEFFAF POLİKARBONAT VİZÖR. 39 x 20 CM. 354 GR			
EN166 EN1731 EN170 GS-ET 29:2011-05	EN166 1 BT	EN166 1 AT 89 EN170 UV 2C-1.2	EN166 1 FT 8 EN170 UV 2.C 1.7 GS-ET 29 8-1-0 ASTM F 2178-12 1+2 14cal/cm ² ASTM	EN166 1 BT / 3 BT			
BARRIER 2	BARRIER PLATE	SCREEN	SCREEN PLATE				
Koli İçi 6	Kutu İçi 1	Koli İçi 100	Paket 5	Koli İçi 6	Kutu İçi 1	Koli İçi 150	Paket 5
EVOLUTION BARRIER2	EVOLUTION BARRI2PPIN	EVOLUTION SCREEN	EVOLUTION SCREENPPIN				
ELEKTRİK ARK KAYNAĞI İÇİN KENDİNDEN KARARAN CAMLI BAŞLIK 9'DAN 13'E KORUMA TÜM KAYNAK TİPLERİNE UYGUN AYARLANABİLİR RENK TONUNA SAHİP KAYNAK MASKESİ 500 GR	BARRIER2 İÇİN 5 ADET POLİKARBONAT HARİCİ YEDEK CAM 38 GR	ELEKTRİK ARK KAYNAĞI İÇİN KENDİNDEN KARARAN CAMLI BAŞLIK TIG VE MIG KAYNAK UYGULAMALARINA UYGUN KAYNAK MASKESİ 474 GR	SCREEN İÇİN 5'Lİ YEDEK POLİKARBONAT SİPERLİK PAKETİ 14 GR				
EN379 1/1/1/2 / 4/5-13 EN175 B	EN 166:2001 1 B Cam	EN 166 1 F EN379 1/1/1/2 / 4/9 EN175 F					

Kafa Koruma Ürünleri											
Güvenlik Kaskları ve Vizörler											
ONYX 2		YEDEK VİZÖR		BARET İÇLİĞİ		AIR COLTAN		GRANITE WIND		GRANITE PEAK	
Koli İçi 6	Kutu İçi 1	Koli İçi 20	Paket 1	Koli İçi 60	Paket 1	Koli İçi 20	Paket 1	Koli İçi 10	Kutu İçi 1	Koli İçi 10	Kutu 1
PREMIUM ONYX2BJ - BEYAZ		PREMIUM VISIONXPRIN		PREMIUM HARNESSO2		EVOLUTION COLTAAIGRMI 3cm COLTAAINOMI 3 cm COLTAAIBMSH 5 cm COLTAAINOSH 5 cm COLTAAIIGR 7 cm COLTAAIJAF 7 cm		PREMIUM GRAWIBCF Beyaz GRAWIBFL Mavi GRAWIJAF Sarı GRAWIORFL Turuncu GRAWIROFL Kırmızı		PREMIUM GRAPEBCFL Beyaz GRAPEBFL Mavi GRAPEJAF Sarı GRAPEROFK Kırmızı	
ABS ÇİFT KABUKLU, ENTEGRE POLİKARBONAT VİZÖRLÜ BARET. ARK FLASH, 1000 VAC ELEKTRİK YALITIMI, VİZÖR K,N. ELEKTRİK ARK, ERİMiŞ METAL VE SICAK SIVI SIÇRAMASINA KARŞI KORUMALI 775 GR				ONYX İÇİN YEDEK BARET İÇLİĞİ TEKLİ PAKET 120 GR		MAKSİMUM KONFOR İÇİN HAVALANDIRMALI ŞAPKA BARET ÇIKARILABİLİR TEKSTİL KISIM 3 DEĞİŞİK VİZÖR UZUNLUĞU (3-5-7 CM) 176 GR		YÜKSEKTE ÇALIŞMA İÇİN HAVALANDIRMALI ABS BARET TEKSTİL 8 NOKTALI İÇLİK 368 GR		YÜKSEKTE ÇALIŞMA İÇİN ELEKTRİK YALITIMLI ABS BARET TEKSTİL 8 NOKTALI İÇLİK 350 GR	
EN397 MM LD -20°C +50°C 440VAC EN50365 CLASS 0						EN812 Bump Camps		EN397 MM -20°C +50°C		EN397 MM -20°C +50°C 440 VAC EN50365:2002 CLASS 0	
EN166 1 SAT 8 9 KN Cam & 3 8 9 AT Çerçeve EN170 2C-1.2 GS-ET 29: 8-1-0 Cam CLASS 1 / CLASS 0 Light transmittance class = Class 1 : (50% ≤ VLT(D65) < 75%) / Class 0 : (VLT(D65) ≥ 75%). 8-1 Çerçeve											
MENTALPHA		DYNAMIC JUGALPHA		BASALPHA		JUGGAMMA		DYNAMIC JUGBETA			
Koli İçi 20	Paket 10	Koli İçi bARET20	Paket 10	Koli İçi 20	Paket 10	Koli İçi 20	Paket 10	Koli İçi 20	Paket 10		
ESSENTIAL MENTAGR		EVOLUTION JUGALDYNGR		ESSENTIAL BASALNO		ESSENTIAL JUGGANO		ESSENTIAL JUGBEDYN			
ÇENE KORUYUCULU 10LU ELASTİK ÇENEKAYIŞI ZIRCON, QUARTZ, QUARTZ UP, SUPER QUARTZ ve BASEBALL DIAMOND BARETLER İÇİN UYGUNDUR 21 GR		QUARTZ, ZIRCON VE BASEBALL DIAMOND BARETLER İÇİN 10'LU ÇENE KAYIŞI PAKETİ YÜKSEKTE ÇALIŞMA İÇİN 4 SABİTLEME NOKTASI 21 GR		10'LU KÖPÜK TER BANDI. ZIRCON, QUARTZ, QUARTZ UP, SUPER QUARTZ, BASEBALL DIAMOND, GRANITE, ONYX ve BALBİ2, VISOR-H İÇİN UYGUNDUR 21 GR		3 SABİTLEME NOKTALI ÇENE KAYIŞI GRANITE SERİSİ İLE UYUMLU 21 GR		4 SABİTLEME NOKTALI ÇENE KAYIŞI ONYX VE DIAMOND İLE UYUMLU 21 GR			

Kafa Koruma Ürünleri							
Güvenlik Kaskları ve Vizörler							
DIAMOND 6 WIND		DIAMOND 5		QUARTZ UP 4		QUARTZ UP 3	
Koli İçi 20	Paket 1	Koli İçi 20	Paket 1	Koli İçi 40	Paket 1	Koli İçi 40	Paket 1
PREMIUM		PREMIUM		EVOLUTION		EVOLUTION	
DIAM6WTRBC Beyaz DIAM6WTRJAF Sarı DIAM6WTRROFL Kırmızı DIAM6WTRVEFL Yeşil DIAM6WTRBL Mavi DIAM6WTRNO Siyah DIAM6WTRNOCA Karbon Siyah		DIAM5BCFL Beyaz DIAM5ROFL Kırmızı DIAM5JAF Sarı DIAM5BLFL Mavi DIAM5VEFL Yeşil DIAM5NO Siyah DIAM5GRJAF Gri-Sarı		QUARUP4BC Beyaz QUARUP4BL Mavi QUARUP4JA Sarı QUARUP4RO Kırmızı QUARUP4VE Yeşil QUARUP4OR Turuncu		QUARUP3BC Beyaz QUARUP3BL Mavi QUARUP3JA Sarı	
ABS GÜVENLİK BARET HAVALANDIRMALI "BEYZBOLKEPI" ŞEKLİNDE - ROTOR® AYARLI 374 GR		ABS GÜVENLİK BARET "BEYZBOL KEPI" ŞEKLİNDE -ROTOR® AYARLI 404 GR		HAVALANDIRMALI POLİPROPİLEN GÜVENLİK BARETİ - ROTOR® AYARLI 350 GR		POLİPROPİLEN GÜVENLİK BARETİ - ROTOR® AYARLI ELEKTRİK YALITIMLI 350 GR	
EN397 MM LD -30°C +50°C		EN397 MM LD -30°C +50°C 440VAC EN50365 CLASS 0		EN397 MM -30°C +50°C		EN397 MM -30°C +50°C 440VAC EN50365 CLASS 0	
HARNE6		HARNE5		HARNE4			
Koli İçi 10	Paket 10	Koli İçi 10	Paket 10	Koli İçi 15	Paket 10		
DIAMOND 6 İÇİN YEDEK TEKSTİL İÇLİK. 10'LU PAKET		DIAMOND 5 İÇİN YEDEK TEKSTİL İÇLİK. 10'LU PAKET		QUARTZUP 3 VE QUARTZUP 4 İÇİN YEDEK TEKSTİL İÇLİK. 10'LU PAKET			
SİYAH		SİYAH		SİYAH			

KAFA KORUMA ÜRÜNLERİ
KULAK KORUYUCULAR

MAGNY HELMET 2		MAGNY COURS 2		INTERLAGOS 2		INTERLAGOS LIGHT		INTERLAGOS LIGHT HE		INTERLAGOS NB2	
Koli İçi 20	Kutu İçi 1	Koli İçi 20	Kutu İçi 1	Koli İçi 20	Kutu İçi 1	Koli İçi 50	Kutu İçi 1	Koli İçi 20	Kutu İçi 10	Koli İçi 20	Kutu İçi 1
PREMIUM		PREMIUM		EVOLUTION		EVOLUTION		EVOLUTION		EVOLUTION	
MAGN2HENO		MAGN2NO		INTERGR2		INTERLIGHT		INTERLIGHTHE		INTERNB	
SİYAH		SİYAH		GRİ		GRİ		GRİ		GRİ	
QUARTZ, GRANITE ve DIAMOND İÇİN ABS GÖVDELİ KULAK KORUYUCU. TEK VEYA VISOR HOLDER İLE KULLANILABİLİR. 286 GR		ABS GÖVDELİ KULAK KORUYUCU METAL KAFA BANDI 338 GR		ABS GÖVDELİ ÇİFT PLASTİK KAFA BANTLI KULAK KORUYUCU 286 GR		ABS GÖVDELİ VE KAFA BANTLI KULAK KORUYUCU 200 GR		ABS BARETE TAKILABİLİR KULAKLIK GRANITE, QUARTZ VE DIAMOND İLE UYUMLU 249 GR		BOYUN ARKASINDAN TAKILAN METAL YAY VE ABS GÖVDELİ KULAK KORUYUCU 247 GR	
EN352-1 SNR 30 dB H 32 M 28 L 22		EN352-1 SNR 33 dB H 34 M 32 L 25		EN352-1 SNR 29 dB H 30 M 28 L 20		EN352-1 SNR 26 dB H 30 M 25 L 15		EN352-1 SNR 26 dB H 28 M 24 L 16		EN352-1 SNR 27 dB H 33 M 26 L 15	
CONICFIT 100		CONICFIR 050		CONICCO2 200		CONIC2 200		CONIC DISPLAY		CONIC2 500	
Koli İçi 10	Kutu İçi 100	Koli İçi 20	Kutu İçi 50	Koli İçi 5	Kutu İçi 200	Koli İçi 5	Kutu İçi 200	Koli İçi 4	Paket 1	Koli İçi 5	Kutu İçi 1000
EVOLUTION		PREMIUM		EVOLUTION		ESSENTIAL		EVOLUTION		ESSENTIAL	
CONICFIT100OR TURUNCU		CONICFIR050OR SİYAH		CONICCO200JA KIRMIZI		CONIC2200JA KIRMIZI		CONICDISGR KIRMIZI		CONIC500JA KIRMIZI	
KOLAY KULLANILABİLİR TEK KUTUDA 100 ÇİFT SİLİKON TEKRAR KULLANILABİLİR KULAK TIKACI PVC İP 547 GR		TEK KUTUDA 50 ÇİFT KORDONLU YENİDEN KULLANILABİLİR TERMOPLASTİK KULAK TIKACI KUTUSU DAHİL		200 ÇİFT PLASTİK İPLİ TEK KULLANIMLIK PU KÖPÜK KULAK TIKACI KUTULU- 500 GR		200 ÇİFT PU KÖPÜK KULAK TIKACI 215 GR		KULAK TIKACI DISPENSER - 500 ÇİFT CONIC500 DAHİL - 1.300 GR		500 ÇİFT PU KÖPÜK KULAK TIKACI KUTUSU - CONICDISGR DISPENSER DOLUM İÇİN - 520 GR	
EN352-2 SNR 32 dB H 32 M 29 L 28		EN352-2 SNR 34 dB H 33 M 32 L 31		EN352-2 SNR 37 dB H 37 M 35 L 30		EN352-2 SNR 37 dB H 37 M 35 L 30		EN352-2 SNR 37 dB H 37 M 35 L 30		EN352-2 SNR 37 dB H 37 M 35 L 30	

KAFA KORUMA ÜRÜNLERİ
MASKELER

M9300 GALAXY STRAP		M9000 ABEK2		M9000 ABEK2P3		M9000 A2P3			
Koli İçi 6	Kutu İçi 1	Koli İçi 10	Kutu İçi 4	Koli İçi 10	Kutu İçi 4	Koli İçi 10	Kutu İçi 4		
PREMIUM		PREMIUM		PREMIUM		PREMIUM			
SİYAH		KAHVERENGI-GRI-SARI-YEŞİL		KAHVERENGI-GRI-SARI-YEŞİL BEYAZ		KAHVERENGI-BEYAZ			
KAYIŞ AYARLAMALI TAM YÜZ MASKE POLİKARBONAT CAM (210°) BUĞUYU AZALTMAK İÇİN İÇERİDE SİLİKON YARIM MASKE (3 NEFES ALMA VALFİ, 1 NEFES VERME VALFİ, SES SİSTEMİ) AYARLANABİLİR BEDEN. M9000 SERİSİ FİLTRELER İLE UYUMLU, FİLTRE AYRI SATILIR. SAKLAMA ÇANTASI DAHİL 616 GR		TAM YÜZ MASKELER İÇİN 4'LÜ A2B2E2K2 FİLTRE		TAM YÜZ MASKELER İÇİN 4'LÜ A2B2E2K2P3 FİLTRE		TAM YÜZ MASKELER İÇİN 4'LÜ A2P3 FİLTRE			
EN136 SINIF 3 EN148-1		EN148-1 EN14387 A2B2E2K2		EN148-1 EN14387 A2B2E2K2P3		EN148-1 EN14387 A2P3R			
M6400		M6000 ABEK1		M6000 P3		M6000 A2		M6000 PREP3	
Koli İçi 20	Kutu İçi 1	Koli İçi 30	Kutu İçi 2	Koli İçi 30	Kutu İçi 2	Koli İçi 30	Kutu İçi 2	Koli İçi 30	Kutu İçi 2
EVOLUTION		EVOLUTION		EVOLUTION		EVOLUTION		EVOLUTION	
M6400GT		M6000ABEK1		M6000P3R		M6000A2R		M6000PREP3R	
GRİ-SİYAH		KAHVERENGI-GRI-SARI-YEŞİL		BEYAZ		KAHVERENGI		BEYAZ	
KONFORLU YARIM MASKE, M6000 SERİSİ 2 FİLTRE İLE KULLANILIR FİLTRE AYRI SATILIR		M6200 - M6100 - M6400 YARIM MASKELER İÇİN 2 ADET A1B1E1K1 FİLTRE KARTUŞU		M6200 - M6100 - M6400 YARIM MASKELER İÇİN 2 ADET P3 FİLTRE KARTUŞU		M6200 - M6100 - M6400 YARIM MASKELER İÇİN 2 ADET A2 FİLTRE KARTUŞU		M6200 - M6100 - M6400 YARIM MASKELER İÇİN 2 ADET P3 PREFILTERS ve 2 ADAPTATORS	
66 GR		EN14387 A1B1E1K1		EN14387 P3R		EN14387 A2		EN14387 P3R	
EN140		EN14387 A1B1E1K1		EN14387 P3R		EN14387 A2		EN14387 P3R	

KAFA KORUMA ÜRÜNLERİ

TEK KULLANIMLIK MASKELER

M1300V FFP3		M1300VB FFP3		M1305V FFP3		M1305VW FFP3	
Koli İçi 10	Kutu İçi 5	Koli İçi 10	Kutu İçi 10	Koli İçi 10	Kutu İçi 10	Koli İçi 10	Kutu İçi 10
PREMIUM		EVOLUTION		EVOLUTION		EVOLUTION	
M1300VC		M1300VBC		M1304VC/M1305VC		M1304VWC/M1305VWC	
BEYAZ		BEYAZ		BEYAZ		GRİ	
5'LİK KUTU VENTİLLİ FFP3 DOLOMIT KALIPLI TOZ MASKESİ FFP3 NR D		10'LUK KUTU VENTİLLİ FFP3 DIKEY KATLANAN TOZ MASKESİ - TEK POŞET - FFP3 NR D		10'LUK KUTU FFP3 KALIPLI VENTİLLİ MASKE-DOLOMIT FFP3 NR D		10'LUK KUTU AKTİF KARBON FFP3 VENTİLLİ MASKE. 4 KATLI. BURUN KLİPSİ. DOLOMIT FFP3 NR D	
EN149		EN149		EN149		EN149	
M1200V FFP2		M1200VB FFP2		M1200VW FFP2		M1205V FFP2	
Koli İçi 10	Kutu İçi 10	Koli İçi 10	Kutu İçi 10	Koli İçi 10	Kutu İçi 10	Koli İçi 10	Kutu İçi 10
EVOLUTION		EVOLUTION		EVOLUTION		EVOLUTION	
M1200VC		M1200VBC		M1200VWC		M1204VC/ M1205VC	
BEYAZ		BEYAZ		GRİ		BEYAZ	
10'LUK KUTU FFP2 KALIPLI VENTİLLİ MASKE-DOLOMIT FFP2 NR D		10'LUK KUTU VENTİLLİ FFP2 DIKEY KATLANAN TOZ MASKESİ - TEK POŞET - DOLOMIT FFP2 NR D		ORGANİK BUHARLAR İÇİN 10'LU KUTUDA AKTİF KARBON VENTİLLİ FFP2 MASKE. AYARLAMA İÇİN BURUN KLİPSİ, KLİPS ALTINDA KÖPÜK KENAR - DOLOMIT FFP2 NR D		10'LUK KUTU FFP2 KALIPLI VENTİLLİ MASKE-DOLOMIT FFP2 NR D	
EN149		EN149		EN149		EN149	

EL KORUMA ÜRÜNLERİ

VECUTF01		VECUTD00		VECUTD03		VECUTD04		VECUTD05	
Koli İçi 60	Paket 12	Koli İçi 60	Paket 12	Koli İçi 60	Paket 12	Koli İçi 60	Paket 12	Koli İçi 60	Paket 12
PREMIUM		PREMIUM		PREMIUM		PREMIUM		PREMIUM	
VECUTF01NO		VECUTD00BL		VECUTD03GR		VECUTD04NO		VECUTD05NO	
GRİ SİYAH		MAVİ		SİYAH		SİYAH		SİYAH	
7-8-9-10		7-8-9-10		7-8-9-10		8-9-10		7-8-9-10	
ÖRME XTREMCUT YÜKSEK PERFORMANSLI FİBER. NİRTİL KÖPÜK KAPLAMA - BAŞPARMAK ARASI EK DESTEK - UZUN KONÇ ÖLÇÜ 13		KAPLAMASIZ SOFTnocut UZUN KONÇLU GIDA UYUMLU ELDİVEN ÖLÇÜ 15		ÖRME DELTANOCUT® + AVUÇ İÇİ ÇİFT NİTRİL MİKRO KÖPÜK KAPLAMA ELDİVEN - UZUN KONÇ - PARMAR ARASI TAKVIYE - UZUN KONÇ ÖLÇÜ 15		ÖRME DELTANOCUT® TAM NİTRİL + AVUÇ İÇİ ÇİFT NİTRİL KAPLAMA ELDİVEN UZUN KONÇ - 10 CM ÖLÇÜ 13		DELTA nocut CARBON AVUÇ İÇİ VE PARMARLAR PU KAPLAMA SOLVENT, SİLİKON, DMF İÇERMİYEN ANTİSTATİK ELDİVEN - ÖLÇÜ-18	
EN420 5 EN388 4X43F		EN420 5 EN388 4X43D		EN420 5 EN388 4X43D		EN420 5 EN388 3X43D		EN420 5 EN388 3X41D EN407 X1XXXX EN16350	
Koli İçi 60	Paket 12	Koli İçi 60	Paket 12	Koli İçi 60	Paket 12	Koli İçi 60	Paket 12	Koli İçi 40	Paket 4
EVOLUTION		EVOLUTION		PREMIUM		ESSENTIAL		ESSENTIAL	
VECUTDX0GJ		VECUTD02GJ		VV910JA		ECONOCUTDM1GR		VECUTD08GRG3	
GRİ		GRİ		GRİ/SARI		GRİ		GRİ	
9-10		7-8-9-10		8-9-10-11		STANDART		7-8-9-10	
TAEKI® 5 YÜKSEK PERFORMANSLI POLİETİLEN ELYAF.YARMA DERİ - ÖLÇÜ 10		HEATnocut® YÜKSEK PERFORMANSLI POLİETİLEN ELYAF. AVUÇ İÇİ VE PARMARLAR LATEX KAPLAMA - ÖLÇÜ 10		METAKARPAL KORUMA; KESİLMİYEKARŞI DAYANIKLI - ÇİFT NİTRİL KAPLAMA - SIRT VE PARMAR UÇLARINDA NEOPREN GÜÇLENDİRME		BİR ÇİFT ECONOCUT® BAŞPARMAK DELİKLİ ÖRME KOLLUK - UZUNLUK 55 CM -ÖLÇÜ 13		ECONOCUT® YÜKSEK PERFORMANSLI POLİETİLEN ELYAF.PÜ KAPLAMA. ÖLÇÜ13. 3'LÜ PAKET	
EN420 5 EN388 4X42D EN407 X2XXXX		EN420 5 EN388 3X42D EN407 X2XXXX		EN420 5 EN388 4X42DP EN13594 4.1.3/6.8.2.		EN420 5 EN388 2X4XD		EN420 5 EN388 4X42D	

EL KORUMA ÜRÜNLERİ

VV835 ANTICUT	VE766	VE780	VE920	VE509
Koli İçi 60 Paket 6	Koli İçi 60 Paket 6	Koli İçi 120 Paket 12	Koli İçi 120 Paket 12	Koli İçi 120 Paket 12
PREMIUM	PREMIUM	PREMIUM	EVOLUTION	EVOLUTION
VV835CUTVE	VE766BL	VE780BL	VE920BL	VE509NO
YEŞİL 8-9-10	MAVİ 8-9-10	MAVİ 9-10	MAVİ 6/7-7/8-8/9-9/10-10/11	SİYAH 6/7-7/8-8/9-9/10-10/11
C SEVİYE KESİLME DİRENCİ VE 100 DERECE TEMAS ISISI DAYANIMLI NİTREX KİMYASAL ELDİVEN KESİLME DİRENÇLİ ASTARDA YÜKSEK GÖRÜNÜRLÜK 34 CM UZUNLUK 1.7 MM KALINLIK	KİMYASAL PVC PAMUK DOKUMA ASTAR ÜSTÜNE PVC 62 CM UZUNLUK KALINLIK 1.3 MM	PAMUK JARSE ASTAR ÜSTÜNE TAM PVC KAPLAMA - HİDROKARBÜR - 30 CM ÖLÇÜ 13 KALINLIK 1.3 MM	PAMUK FLOKLU LATEKS ELDİVEN - UZUNLUK 30 CM - 100 DERECE ISI TEMAS DAYANIMI KALINLIK 1.25 MM	PAMUK FLOKLU NEOPREN ELDİVEN - UZUNLUK 30 CM - KALINLIK 0,75 MM -
EN420 5 EN388 4X42C EN407 X1XXXX EN ISO 374-1 TİP B JKL EN ISO 374-5 BAKTERİ MANTAR	EN420 5 EN388 4131X EN ISO 374-1 TİP B JKL EN ISO 374-5 BAKTERİ MANTAR	EN420 5 EN388 4131X EN ISO 374-1 TİP B JKL EN ISO 374-5 BAKTERİ MANTAR	EN420 5 EN388 4121X EN ISO 374-1 TİP A AKLMNPT EN ISO 374-5 BAKTERİ MANTAR	EN420 5 EN388 3110X EN ISO 374-1 TİP A AKLMNPT EN ISO 374-5 BAKTERİ MANTAR

VE846	VE802 NITREX	VE801 NITREX	VE330	V1400B100
Koli İçi 36 Paket 12	Koli İçi 120 Paket 12	Koli İçi 120 Paket 12	Koli İçi 144 Paket 12	Koli İçi 10 Paket 1
EVOLUTION	EVOLUTION	ESSENTIAL	PREMIUM	EVOLUTION
VV835VE	VE802VE	VE801VE	VE330BJ	V1400B100
YEŞİL 8/9-9/10-10/11	YEŞİL 6/7-7/8-8/9-9/10-10/11	YEŞİL 8-9-10	SARI-MAVİ	MAVİ 6/7 -7/8 -8/9-9/10
ÖNKOL KORUMASI İÇİN UZUN PAMUK FLOKLU NİTRİL ELDİVEN UZUNLUK 46 CM KALINLIK 0.55 MM	PAMUK FLOKLU NİTRİL ELDİVEN - UZUNLUK 33 CM KALINLIK 0.38 MM	PAMUK FLOKLU NİTRİL ELDİVEN - UZUNLUK 33CM KALINLIK 0.40 MM	PAMUK ASTARLI LATEX ÇİFT DALDIRMA 30 CM KALINLIK 0.60 MM	100'LÜK KUTU TEK KULLANIMLIK PUDRASIZ NİTRİL ELDİVEN- AQL 1,5 KALINLIK 0.07 MM LATEX, SİLİKON, DMF İÇERMEZ
EN420 5 EN388 4102X EN ISO 374-1 TİP A AGJLMNPT EN ISO 374-5 BAKTERİ MANTAR	EN420 5 EN388 4101X EN ISO 374-1 TİP A AJKLMNPT EN ISO 374-5 BAKTERİ MANTAR	EN420 5 EN388 3101X EN ISO 374-1 TİP B JKL EN ISO 374-5 BAKTERİ MANTAR	EN420 5 EN388 1010X EN ISO 374-1 TİP A AKLMNPT EN ISO 374-5 BAKTERİ MANTAR	EN420 5 EN ISO 374-1 TİP B JKT EN ISO 374-5 BAKTERİ MANTAR EN455-1 / EN455-2/ EN455-3

VÜCUT KORUMA ÜRÜNLERİ

TEK KULLANIMLIK TULUMLAR /PVC ÖNLÜK

DT300	DT117	DT115	DT215	TABALPV
Koli İçi 20 Paket 1	Koli İçi 20 Paket 1	Koli İçi 50 Paket 1	Koli İçi 50 Paket 1	Koli İçi 50 Paket 1
PREMIUM	EVOLUTION	EVOLUTION	EVOLUTION	ESSENTIAL
DT300	DT117	DT115	DT215	TABALPV
SARI	BEYAZ	BEYAZ	BEYAZ	BEYAZ
M-L-XL-XXL	M-L-XL-XXL	M-L-XL-XXL	M-L-XL-XXL	STANDARD
DELTACHEM® KAPUŞONLU TULUM	DELTATEK 5000® KAPUŞONLU TULUM	KAPUŞONLU TULUMLAR	KAPUŞONLU TULUMLAR	PVC ÖNLÜK BOYUNDAN AYARLAMA 120 CM X 90 CM KALINLIK: 0,30MM
EN ISO 13688 EN14605 TİP 3B 4B EN ISO 13982 TİP 5B EN13034 TİP 6B EN14126 EN1073-2 SINIF 1 EN1149-5	EN ISO 13688 EN ISO 13982 TİP 5B EN13034 TİP 6B EN14126 EN1073-2 SINIF 1 EN1149-5	EN ISO 13688 EN ISO 13982- TİP 5B EN13034 TİP 6B EN1149-5	EN ISO 13688 EN ISO 13982 TİP 5B EN13034 TİP 6B	

İŞ KİYAFETLERİ

M5PA2	M5VE3	M2PA3	M2VE3	M2GI3	ZIMA
Koli İçi 10 Paket 1	Koli İçi 10 Paket 1	Koli İçi 10 Paket 1	Koli İçi 10 Paket 1	Koli İçi 10 Paket 1	Koli 10 Paket 1
PREMIUM	PREMIUM	EVOLUTION	EVOLUTION	EVOLUTION	EVOLUTION
M5PA3GN	M5VE3GN	M2PA3GO	M2VE3GO	M2GI3GO	ZIMANO
GRİ	GRİ	GRİ	GRİ	GRİ	SİYAH
S-M-L-XL-XXL-3XL	S-M-L-XL-XXL	S-M-L-XL-XXL	S-M-L-XL-XXL	S-M-L-XL-XXL	STANDARD
MACH 5 PANTOLON DÜZ KESİM ARKA VE ÖN ELASTİK BEL. DİZLİK YERİ 10 C EP 40% POLYESTER 60% PAMUK 280 g/m ²	MACH 5 9 CEPLİ YELEK 40% POLYESTER 60% PAMUK 290 g/m ²	MACH 2 PANTOLON DÜZ KESİM ARKA VE ÖN ELASTİK BEL. DİZLİK YERİ 7 CEP 65% POLYESTER 35% PAMUK 245 g/m ²	MACH 2 CEKET - ELASTİK BİLEKLER ÖN VE ARKA ELASTİK BEL 1 İÇ TOPLAM 7 CEP 65% POLYESTER - 35% PAMUK 245 g/m ²	MACH 2 ÇOK CEPLİ YELEK 65% POLYESTER 35% PAMUK 245 g/m ²	DİŞİ KAYMAZ BİR ÇİFT JEL DİZLİK. DİZİ KORUMAK İÇİN AYARLANABİLİR ELASTİK BANT
EN ISO 13688	EN ISO 13688	EN ISO 13688	EN ISO 13688	EN ISO 13688	EN ISO 13688
EN14404 DİZ KORUMA TİP2 SEVİYE 1		EN14404 DİZ KORUMA TİP2 SEVİYE 0			EN14404 TİP1 & TİP2

VÜCUT KORUMA ÜRÜNLERİ

KIŞLIK ÜRÜNLER

SPEED		OPTIMUM3		EASYVIEW	
ESSENTIAL SPEEDJM		EVOLUTION OPTI3JMG		ESSENTIAL EASYVJM	
S,M,L,XL,XXL,3XL		S,M,L,XL,XXL,3XL		S,M,L,XL,XXL,3XL	
HV PU KAPLI OXFORD POLYESTER 5'i 1 ARADA MONT - SINIF 3 - ÇIKARILABİLİR VÜCUT ISITICI- SINIF 2 EN ISO 13688		SU GEÇİRMEZ 5'i 1 ARADA MONT - SINIF 3 - ÇIKARILABİLİR VÜCUT ISITICI- SINIF 2 EN ISO 13688		HV PU KAPLI OXFORD POLYESTER - SINIF 3 - ÇIKARILABİLİR VÜCUT ISITICI- SINIF 2 EN ISO 13688	
EN343 3 1* X		EN343 3 1* X		EN343 3 1* X	
EN ISO 20471 PARKA/MONT/VÜCUT ISITICI 3/3/2		EN342 0,386 m² K/W (B) / 2 / X		EN ISO 20471 PARKA/MONT/VÜCUT ISITICI 3/3/2	
MILTON2		AREN		MYSEN2	
ESSENTIAL MILT2NO		EVOLUTION ARENNO		EVOLUTION MYSE2GN Erkek - MYS2FGN Kadın	
SİYAH		SİYAH		GRİ	
S,M,L,XL,XXL,3XL		S,M,L,XL,XXL,3XL		S,M,L,XL,XXL,3XL	
SU GEÇİRMEZ NEFES ALIR PARKA 6 CEPLİ İÇ MANŞETLER		SU GEÇİRMEZ DİKİŞLİ PARKA. ÇİTÇİTLİ AYARLANABİLİR MANŞETLER. 1 FERUARLI İÇ OLMAK ÜZERE 4 CEP. 2 KATMANLI		MACH2 SERİSİ İLE UYUMLU ÇIKARILABİLİR KOLLARI İLE YELEKOLABİLEN SOFTSHELL ÇEKET 5 CEPLİ %96 POLYESTER %4 ELASTANKADIN VE ERKEK KESİMİ	
EN ISO 13688		EN ISO 13688		EN ISO 13688	
EN343 31*X		EN343 31*X		EN343 31*X	

AYAK KORUMA ÜRÜNLERİ

AYAKKABI VE BOTLAR

MIAMI S1P SRC		COMO S1P SRC		BROOKLYN S3 SRC HRO	
ESSENTIAL MIAMISPGB Mavi MIAMISPNO Siyah SİYAH-MAVİ		ESSENTIAL COMOSPBL LACİVERT		PREMIUM BROOKS3NO SİYAH	
35-48		39-48		39-47	
POLYESTER / PAMUK AYAKKABI -TEK YOĞUNLUKLU PU DIŞ TABAN -METAL BURUN KORUMA ÇIKARILABİLİR İÇ TABANLIK		SÜET YARMA DERİ VE POLYESTER AĞ. ÇIKARILABİLİR ÖNCEDEN KALIPLANMIŞ EVA ÜZERİNE POLYESTER İÇ. YÜKSEK ESNEKLİK ENJEKTE TEK YOĞUNLUKLU PU DIŞ TABAN - METAL BURUN		PIGMENTLİ YARMA DERİ AYAKKABI - NUBUK VE NAYLON MESH - PU/LASTİK TABAN - KOMPOZİT BURUN VE İÇ TABAN KAÜÇUK DIŞ TABAN	
442 GR		508 GR		524 GR	
EN ISO 20344 EN ISO 20345 S1P SRC		EN ISO 20344 EN ISO 20345 S1P SRC		EN ISO 20344 EN ISO 20345 S3 HRO SRC	
GOBI S3 SRC		TAKU S3 SRC CI		TW402 S3 SRC HRO HI CI	
EVOLUTION GOBIS3MA KAHVERENGİ		EVOLUTION TAKUS3MA KAHVERENGİ		PREMIUM TW402S3NO SİYAH	
36-48		36-48		40-48	
PU KAPLI YARMA İNEK DERİ BOTSUYA DAYANIKLI S3 VE PU KAPLAMALI SÜET YARMA DERİ ÜST. EMİCİ 3D FİLE ASTAR EVA ÜZERİ POLYESTER ÇIKARILABİLİR TABAN. ÇİFT YOĞUNLUKLU PU ENJEKTE DIŞ TABAN KOMPOZİT BURUN METAL ARA TABAN		PU KAPLAMALI PİGMENTLİ YARMA DERİ VE İNEK DERİKÜRK ASTARLI BOT İ SUYA DAYANIKLI S3 VE PU KAPLAMALI SÜET YARMA DERİ ÜST. POYLYESTER KÜRK İÇ ASTAR. EVA ÜZERİNE POLYESTER ÇIKARILABİLİR TABAN. -30°C DAYANIMLI ÇİFT YOĞUNLUKLU PU ENJEKTE DIŞ TABAN KOMPOZİT BURUN METAL ARA TABAN		PIGMENTLİ YARMA DERİ BOT- PU/LASTİK TABAN - KOMPOZİT BURUN VE İÇ TABAN 300°C'YE KADAR TEMAS İSİSİNA DAYANACAK ŞEKİLDE TASARLANMIŞ TABAN TUTUŞU SAYESİNDE YÜKSEK STABİLİTE	
670 GR		740 GR		972 GR	
EN ISO 20344 EN ISO 20345 S3 CR SRC		EN ISO 20344 EN ISO 20345 S3 CI CR SRC		EN ISO 20344 EN ISO 20345 S3 HRO HI CI SRC	

ÇİZMELER	
NICKEL S5 CI SRC	COPPER S5 SRA
Koli İçi 6	Paket 1
EVOLUTION NICKES5NO	ESSENTIAL COPPE5VE
SİYAH 39-46	YEŞİL 39-48
PVC ÇİZME POLYESTER KÜRK KAPLAMA İÇ SAYESİNDE YALITIM ÖZELLİĞİ GİYİM KOLAYLIĞI İÇİN İKİ YANDA KULAKÇIKLAR. ÇELİK BURUN ÇELİK TABAN KORUMA. TABAN : PVC 27 CM	PVC ÇİZME. İÇ KAPLAMASI POLYESTER. AYAK BİLEĞİ KORUMA ARKA TARAFTA KOLAY ÇIKARIM İÇİN TASARLANMIŞ TASARIM ÇELİK BURUN ÇELİK TABAN KORUMA TABAN : PVC NİTRİL 39 CM
1200 GR	1112 GR
EN ISO 20344	EN ISO 20344
EN ISO 20345 S5 CI SRC	EN ISO 20345 S5 SRA
AEROFOODS4	
Koli İçi 6	Paket 1
PREMIUM AEFOOS4BC	
BEYAZ-MAVİ 35-49	
GIDA ENDÜSTRİSİ İÇİN ÖZEL OLARAK TASARLANMIŞ ZARIF TASRIMA SAHİP ULTRA HAFİF VE KONFORLU GÜVENLİK ÇİZMESİ	
SPRAY PU ENJEKSİYON TEKNOLOJİSİ İLE ÜRETİLMİŞ EN YENİLİKÇİ ÇİZME	
METAL BURUN / YÜKSEK SOĞUK DAYANIMI / MÜKEMMEL TABAN TUTUŞU	
800 GR	
EN ISO 20345 S4 CI FO A E SR	

YÜKSEKTE ÇALIŞMA ÜRÜNLERİ EMNİYET KEMERLERİ VE AKSESUARLAR			
HAR44EL	HAR35M	HAR35R	HAR32M
Koli İçi 5	Paket 1	Koli İçi 5	Paket 1
PREMIUM HAR44ELGT- S/M/L HAR44ELXX-XL/XXL	PREMIUM HAR35MGT: S/M/L HAR35MXX: XL/XXL	PREMIUM HAR35RPT - S; HAR35RGT - M/L HAR35RXX - XL / XXL	PREMIUM HAR32MGT: S/M/L HAR32MXX: XL/XXL
SİYAH	GRI-SARI	SİYAH	GRI-SARI
DİELEKTRİK EMNİYET KEMERİ KONUMLAMA KEMERİ 2 DÜŞME ÖNLEYİCİ ANKRAJ NOKTASI (ARKA-ÖN) 4 AYAR TOKASI KONFOR İÇİN GENİŞ VELCRO BANTLI VE TERMOFORM SIRTLI 180° DÖNÜŞ. KONUMLAMA İÇİN İKİ YAN ANKRAJ. PLASTİK KAPLAMALI TOKALAR 20 kv'YA YALITKANLIK SAĞLAR	KONUMLANDIRMA KEMERLİ İKİ RENKLİ EMNİYET KEMERİ. 2 DÜŞME ÖNLEYİCİ BAĞLANTI NOKTASI (ARKA-ÖN) 3 OTOMATİK TOKA DAHİL 5 AYAR TOKASI. TERMO SIRTLI KONUMLANDIRMA, 120° DÖNÜŞ. 2 KONUMLANDIRMA (YANAL) 1 KISITLAMA (ARKA) NOKTASI OMUZLARDA YUMUŞAK DOLGU.	İPTE ÇALIŞANLARIN ERGONOMİ OPTİMİZASYONU İÇİN TASARLANMIŞ EMNİYET KEMERİ 2 OTOMATİK TOKA DAHİL 4 AYARLAMA TOKASI. 2 DORSAL; 2 KEMER VE 1 ARKA OLMAK ÜZERE 5 ANKRAJ NOKTASI , 120° DÖNÜŞ. SIRT VE BEL DESTEĞİ	İKİ RENKLİ EMNİYET KEMERİ. 2 DÜŞME ÖNLEYİCİ ANKRAJ NOKTASI (ARKA-ÖN) 3 OTOMATİK TOKA DAHİL 5 AYAR TOKASI. OMUZ VE PELVİS SEVİYESİNDE YUMUŞAKDOLGU. KAYIŞLAR : POLYESTER
EN358 EN361 - 150 kg	EN361 - 150 kg EN358 - 150 kg	EN358 EN361 - 150 kg EN813 - 150 kg	EN368 EN361 - 150 kg
HAR25 PUMA	HAR24HA	HAR24H	HAR22X
Koli İçi 5	Paket 1	Koli İçi 5	Paket 1
EVOLUTION HAR25GT: S/M/L; HAR25XX: XL/XXL	EVOLUTION HAR24HAGT: S/M/L HAR24HAXX: XL/XXL	EVOLUTION HAR24HGT: S/M/L HAR24HXX: XL/XXL	EVOLUTION HAR22XHGT: S/M/L HAR22XXX: XL/XXL
SİYAH	SİYAH	SİYAH	SİYAH
İPLE ERİŞİM İÇİN EMNİYET KEMERİ 2 DÜŞME ÖNLEYİCİ ANKRAJ NOKTASI (ARKA ÖN) TERMOFORM SIRT VE BACAĞI DESTEKLİ KONUMLANDIRMA 2 KONUMLANDIRMA VEYA SINIRLANDIRMANOKTASI (YANAL) 1 SÜSPANSİYON NOKTASI (KARIN) 6 AYARLANABİLİR TOKA 2 PARK KORDONU	KONUMLANDIRMA KEMERLİ EMNİYET KEMERİ 2 DÜŞME ÖNLEYİCİ ANKRAJ NOKTASI(ARKA-ÖN) 6 AYAR TOKASI KAPANAN TERMOFORM SIRTLI KONUMLANDIRMA KEMERİ KONUMLANDIRMA İÇİN 2 YAN ANKRAJ NOKTASI	MAKSİMUM HAREKET ÖZGÜRLÜĞÜ İÇİN KONUMLANDIRMA KEMERLİ EMNİYET KEMERİ 2 DÜŞME ÖNLEYİCİ ANKRAJ NOKTASI(ARKA-ÖN)2 YANAL NOKTA	METAL PARÇA İÇERMİYEN EN HAFİF YENİLİKÇİ EMNİYET KEMERİ SADECE 580 GR. PATENTLİ D NOKTASI 2 DÜŞME ÖNLEYİCİ NOKTA
EN361 - 150 kg EN358 - 150 kg EN813- 150 kg	EN361 - 150 kg EN358 - 150 kg	EN361 - 150 kg EN358 - 150 kg	EN361 - 150 kg

YÜKSEKTE ÇALIŞMA ÜRÜNLERİ
EMNİYET KEMERLERİ VE AKSESUARLAR

HAR22HA		HAR22H	
YENİ		YENİ	
Koli İçi 5	Paket 1	Koli İçi 5	Paket 1
EVOLUTION		EVOLUTION	
HAR22HAGT : S/M/L HAR22HAXX: XL /XXL		HAR22HAGT : S/M/L HAR22HAXX: XL /XXL	
SİYAH		SİYAH	
MAKSİMUM HAREKET ÖZGÜRLÜĞÜ İÇİN 2 BAĞLANTI NOKTALI VE OTOMATİK TOKALI EMNİYET KEMERİ		MAKSİMUM HAREKET ÖZGÜRLÜĞÜ İÇİN 2 BAĞLANTI NOKTALI EMNİYET KEMERİ	
EN361 - 150 kg		EN361-130 KG	



HAR12GILNO		HAR14		HAR12		HAR11	
Koli İçi 10	Paket 1	Koli İçi 10	Paket 1	Koli İçi 10	Paket 1	Koli 10	Paket 1
ESSENTIAL		ESSENTIAL		ESSENTIAL		ESSENTIAL	
HAR12GILNOGT: S / M / L HAR12GILNOXX: XL / XXL		HAR14GT: S / M / L HAR14XX: XL / XXL		HAR12		HAR11	
SİYAH		TURUNCU		TURUNCU		TURUNCU	
ÇIKARILAMAZ İŞ YELEKLİ EMNİYET KEMERİ (İÇ EMNİYET KEMERİ: HAR12) 1 TELEFON CEBİ DAHİL 4 CEP		2 DÜŞME ÖNLEYİCİ ANKRAJ NOKTASI (ARKA ÖN) 2 AYARLANABİLİR YANAL NOKTA KONUMLANDIRMA KEMERİ.		2 DÜŞME ÖNLEYİCİ ANKRAJ NOKTASI (ARKA-ÖNE) 2 AYARLANABİLİR TOKA KAYIŞLAR : POLYESTER		1 DÜŞME ÖNLEYİCİ ANKRAJ NOKTASI (ARKA)2 AYARLANABİLİR TOKA KAYIŞLAR : POLYESTER	
EN361 - 140 kg		EN358 EN361 - 140 kg		EN361 - 140 kg		EN361 - 140 kg	

YÜKSEKTE ÇALIŞMA ÜRÜNLERİ
DÜŞÜŞ DURDURUCULAR VE BAĞLANTI EKİPMANLARI

AN10006T		AN10010T2		AN10015T	
Paket 1		Paket 1		Paket 1	
EVOLUTION					
AN10006T		AN10010T2		AN10015T	
6 M		10 M		15 M	
MAXIBLOC ABS KASA POLYESTER ŞOK EMİCİ GALVANİZLİ KABLO Ø 4 MM + 1 AM016 FIRDÖNDÜ KONNEKTÖR VE DÜŞÜŞ GÖSTERGESİ					
EN360 150 kg					

AN13006C2		AN102		AN106PF	
Koli İçi 5	Paket 1	Koli İçi 5	Paket 1	Koli İçi 5	Paket 1
PREMIUM		EVOLUTION		EVOLUTION	
AN13006C2		AN102		AN106PF	
6 M		2.5 M		1.8 M	
MEDBLOC 6 M KORUYUCU ABS KABINLI, POLYESTER KAYIŞ 25MM, 1 FIRDÖNDÜ VE DÜŞÜŞ GÖSTERGESİ + AM002 RFU PPE-R/11.060 V1 KÖŞE YATAY KULLANIM (TYPE A) KESKİN KENAR		MINIBLOC ŞOK EMİCİLİ 46 MM POLYESTER KAYIŞLI DÜŞÜŞ DURDURUCU. KORUMA HAVZASI PLASTİK + AM002.		MIKROBLOC 19.5 MM POLYESTER KAYIŞ VE ENERJİ SÖNÜMLEYİCİLİ DÜŞÜŞ DURDURUCU. POLIAMID GÖVDE. 1 FIRDÖNDÜ. 1 ÇIKARILABİLİR KONNEKTÖR DÜŞÜŞ GÖSTERGELİ 1 KANCA 21 MM AÇIKLIK MOBİL PLATFORM KULLANIMI :ANKRAJ > 3KN. KESKİN KENAR	
EN360 RFU PPE-R/11.060 V1 KÖŞE YATAY KULLANIM (TYPE A)		EN360 - 150 kg		EN360 - 140kg RFU PPE-R/11.060 V1 KÖŞE YATAY KULLANIM (TYPE A), RFU PPE-R/11.085 V1F2 (FACTOR2) DIN19427	

YÜKSEKTE ÇALIŞMA ÜRÜNLERİ

DÜŞÜŞ DURDURUCULAR VE BAĞLANTI EKİPMANLARI









AN14008T		AN18020T		AN18030T			
Paket 1		Paket 1		Paket 1			
EVOLUTION		EVOLUTION		EVOLUTION			
AN14008T		AN18020T		AN18030T			
TURUNCU		KIRMIZI SİYAH		KIRMIZI SİYAH			
8 M		20 M		30 M			
PROTECTOR TETRA KORUYUCU 8 M ABS, 25 MM DOKUMA +1 AM016 FIRDÖNDÜ KONNEKTÖR DÜŞÜŞ GÖSTERGESİ - YATAY KULLANIMKÖŞE KORUMA KESKİN KENAR		PROTECTOR LARGE GALVANİZE ÇELİK KABLOLU ENTEGRE ENERJİ SÖNÜMLEYİCİLİ DÜŞÜŞ DURDURUCU. ABSMUHAFAZA. ATALET FREN SİSTEMİ					
EN360- 100 kg RFU PPE-R/11.060 V1 Köşe Yatay Kullanım - Tip A KESKİN KENAR		EN360 150 kg					
AN245200ADD		AN213200ZDD		AN213150ZDD		LV201	
PREMIUM		EVOLUTION		EVOLUTION		PREMIUM	
SİYAH		TURUNCU		TURUNCU		SARI	
1.40-2.00 M		2 METRE		1.5 METRE		2.5-20 M AYARLANABİLİR	
ENERJİ DAĞITICI ÇİFTLİ ELASTİK KAYIŞLI LANYARD YÜKSÜK DÖNGÜLER, 1 KARABİNA AM002 VE 2 KANCA AM022 İLE DONATILMIŞTIR.		ÇİFT HALAT KAYIŞTAN ŞOK EMİCİLİ LANYARD		ÇİFT HALAT KAYIŞTAN ŞOK EMİCİLİ LANYARD		SPEEDLINE 2 KİŞİ İÇİN GEÇİCİ DOKUMA YATAY YAŞAM HATTI, UZUNLUK 20 M MAKS.	
EN355		EN355 YATAY SERTİFİKASYON RFU 11.062 140 KG		EN795 TYPE B CEN-TS16415 2 KİŞİ EN795 TYPE C			







YÜKSEKTE ÇALIŞMA ÜRÜNLERİ

TC025		AM002x5V2		AM025X2		AN066		AN066A	
Koli İçi 10 Paket 1		Koli İçi 4 Paket 5		Koli İçi 10 Paket 1		Koli İçi 5 Paket 1		Koli İçi 5 Paket 1	
PREMIUM		ESSENTIAL		EVOLUTION		PREMIUM		PREMIUM	
TC025		AM002X5V2		AM025X2		AN066		AN066A	
TURUNCU		ÇELİK		ÇELİK		GRİ-TURUNCU		GRİ-TURUNCU	
HALAT VE KABLO HATLARI İÇİN TASARLANAN BİLYALI RULMANLAR ÜZERİNDE ÇİFT MAKARA EN12278 20 KN		5 ADET VIDALI EMNİYET KARABİNASI-17MM AÇILIR /R>23 KN		2 ADET HAFİF ALAŞIM KARABİNA - AĞIZ 22 MM R>25 KN		CAMELEON KAYAN DÜŞÜŞ DURDURUCU, Ø 10,5 MM IP ÜZERİNE, 1 AM002 KARABİNA		CAMELEON KAYAN DÜŞÜŞ DURDURUCU, Ø 10,5 MM IP ÜZERİNE EK ASKILI VE ENERJİ EMİCİ, 1 AM002 KARABİNA	
EN362 CLASSB		EN362 CLASS B		EN353-2 EN1284 TİP A/B EN358		EN353-2 EN1284 TİP A / B EN358		EN353-2 EN1284 TİP A / B EN358	

TRIPOD SET

		1 ADET TRA22; 1 ADET TR01820U VE 1 ADET TR00520'DEN OLUŞMAKTADIR	
TRA22		TR01820U	
EN795 TİP B TS16415-3		EN360 RFU 11.062 - 150 KG EN1496 CLASS A - 150 KG	
		TR00520	
		MAKİNE DİREKTİFİNE TABİDİR	

S.NO	ÜRÜN RESİMİ PHOTO	ÜRÜN KODU PRODUCT CODE	ÜRÜN ADI PRODUCT NAME	UZUNLUK / LENGHT BEDEN / SIZE	FİYAT SORUNUZ	KOLİ ADETİ PCS	KDV %
EMNİYET KEMERLERİ EN 358 - EN 361 - EN 813 HARNESSES							
1		KP 45	Tam Koruma Düşüş Durdurma ve Konumlandırma Kemer <i>Fall Arrester and Positioning Harness</i> EN 358 - EN 361 - EN 813	BEDEN / SIZE S/M - L/XL - (XXL)		10	10
2		KP 45 A	Tam Koruma Düşüş Durdurma ve Konumlandırma Kemer Aluminyum D Halkalı <i>Fall Arrester and Positioning Harness</i> EN 358 - EN 361 - EN 813	BEDEN / SIZE S/M - L/XL - (XXL)		10	10
3		KP 45 O	Tam Koruma Düşüş Durdurma ve Konumlandırma Kemer Otomatik Tokalı <i>Fall Arrester and Positioning Harness</i> EN 358 - EN 361 - EN 813	BEDEN / SIZE S/M - L/XL - (XXL)		10	10
4		KP 45 AO	Tam Koruma Düşüş Durdurma ve Konumlandırma Kemer Aluminyum D Halkalı & Otomatik Tokalı <i>Fall Arrester and Positioning Harness</i> EN 358 - EN 361 - EN 813	BEDEN / SIZE S/M - L/XL - (XXL)		10	10
5		Kİ 01	Malzeme Askısı Tek Kollu Karabinalı <i>Material Hanger Single Arm with Carabiner</i>	BEDEN / SIZE 62 CM		100	10
6		Kİ 02	Malzeme Askısı Çift Kollu Karabinalı <i>Material Hanger Double Arm With Carabiner</i>	BEDEN / SIZE 72 CM		100	10
7		KT 01	Ayak Askısı (Travma Askısı) <i>Suspension Trauma Straps</i>	BEDEN / SIZE		10	10
8		KÇ 03	KEMER ÇANTASI SİYAH	BEDEN / SIZE 1 ADET		10	10
9		KÇ 06	LANYARD ÇANTASI SİYAH	BEDEN / SIZE 1 ADET		10	10















S.NO	ÜRÜN RESİMİ PHOTO	ÜRÜN KODU PRODUCT CODE	ÜRÜN ADI PRODUCT NAME	UZUNLUK / LENGHT BEDEN / SIZE	FİYAT SORUNUZ	KOLİ ADETİ PCS	KDV %
EMNİYET KEMERLERİ EN 358 - EN 361 HARNESSES							
10		KP 10	Paraşüt Tipi Emniyet Kemer Kolon Halatlı <i>Full Body Harness (With Webbing Lanyard)</i> EN 361 - EN 358	BEDEN / SIZE S/M - L/XL - (XXL)		20	10
11		KP 10	Paraşüt Tipi Emniyet Kemer Statik Halatlı <i>Full Body Harness (With Static Lanyard)</i> EN 361 - EN 358	BEDEN / SIZE S/M - L/XL - (XXL)		20	10
12		KP 30	Paraşüt Tipi Emniyet Kemer (Beli Sabit + Alt bağlantılı) Kolon Halatlı <i>Full Body Harness The Belt Waist Fixed.</i> (with webbing Lanyard) EN 361 - EN 358	BEDEN / SIZE S/M - L/XL - (XXL)		20	10
13		KP 36	Paraşüt Tipi Emniyet Kemer Statik Halatlı <i>Full Body Harness (With Static Lanyard)</i> EN 361 - EN 358	BEDEN / SIZE S/M - L/XL - (XXL)		20	10
14		KP 37	Paraşüt Tipi Emniyet Kemer Bel Desteksiz Statik Halatlı <i>Full Body Harness Without Waist Belt</i> (With Static Lanyard) EN 361	BEDEN / SIZE S/M - L/XL - (XXL)		20	10
15		KP 37 K	Paraşüt Tipi Emniyet Kemer Bel Desteksiz Statik Halatlı <i>Full Body Harness Without Waist Belt</i> (With Static Lanyard) EN 361	BEDEN / SIZE S/M - L/XL - (XXL)		20	10
16		KP 37 Y	Paraşüt Tipi Emniyet Kemer YELEKLİ Statik Halatlı <i>Full Body Harness Belt Without Waist Support with Static</i> Rope and With Vest. EN 361	BEDEN / SIZE S/M - L/XL - (XXL)		20	10











S.NO	ÜRÜN RESİMİ PHOTO	ÜRÜN KODU PRODUCT CODE	ÜRÜN ADI PRODUCT NAME	UZUNLUK / LENGHT BEDEN / SIZE	FIYAT SORUNUZ	KOLI ADETİ PCS	KDV %
ŞOK EMİCİLİ ÇİFT KOLLU LANYARLAR EN 354							
<i>SHOCK ABSORBING LANYARDS</i>							
17		KA 341	Çift Kol Şok Emicili Lanyard Statik Halatlı Karabinalı + Büyük Çelik Kancalı 1,20 MT Double Arm - Shock Absorber with Static Lanyard (With Carabiner + Big Steel Hook) EN 355 - EN 354 - EN 362	BEDEN / SIZE 1,20 MT		15	10
18		KA 341 A	Çift Kol Şok Emicili Lanyard Statik Halatlı Karabinalı + Alüminyum Kancalı 63'lük Double Arm - Shock Absorber with Static Lanyard (with Carabiner + Big Aluminium Hook 63") EN 355 - EN 354 - EN 362	BEDEN / SIZE 1,20 MT		15	10
19		KA 341 E	Çift Kol Şok Emicili Lanyard Statik Halatlı Karabinalı + Elektrikçi Kancalı 58'lük Double Arm - Shock Absorber with Static Lanyard (with Carabiner + Big Electrician Hook 58") EN 355 - EN 354 - EN 362	BEDEN / SIZE 1,20 MT		15	10
20		KA 341 BA	Çift Kol Şok Emicili Lanyard Statik Halatlı Karabinalı + Alüminyum Kancalı 110'lük Double Arm-Shock Absorber with Static Lanyard (with Carabiner + Big Aluminium Hook 110") EN 355 - EN 354 - EN 362	BEDEN / SIZE 1,20 MT		10	10
21		KA 361	Çift Kol Şok Emicili Lanyard Kolon Halatlı Karabinalı + Büyük Çelik Kancalı 1,20 MT Double Arm -Shock Absorber with Webbing Lanyard (with Carabiner + Big Steel Hook) EN 355 - EN 354 - EN 362	BEDEN / SIZE 1,20 MT		20	10
22		KA 361 A	Çift Kol Şok Emicili Lanyard Kolon Halatlı Karabinalı + Alüminyum Kancalı 63'lük 1,20 MT Double Arm -Shock Absorber with Webbing Lanyard (with Carabiner + Big Steel Hook) EN 355 - EN 354 - EN 362	BEDEN / SIZE 1,20 MT		15	10
23		KA 371	Çift Kol Şok Emicili Lanyard Elastik Halatlı Karabinalı + Büyük Kancalı 1,20 MT Double Arm Elastic Lanyard with Shock Absorber . (with Carabiner + Big Hook) EN 355 - EN 354 - EN 362	BEDEN / SIZE 1,20 MT		15	10
24		KA 371 A	Çift Kol Şok Emicili Lanyard Elastik Halatlı Karabinalı + Alüminyum Kancalı 63'lük 1,20 MT Double Arm Elastic Lanyard with Shock Absorber . (with Carabiner + Aluminium Hook) EN 355 - EN 354 - EN 362	BEDEN / SIZE 1,20 MT		15	10
ŞOK EMİCİSİZ ÇİFT KOLLU LANYARLAR EN 354 - EN 362							
<i>Lanyards Without Shock Absorber</i>							
25		Kİ 231	Çift Kol Lanyard Statik Halatlı Karabinalı + Büyük Kancalı 1,20 MT Double Arm Lanyard with Static Lanyard (Carabiner + Big Hook) EN 354 - EN 362	BEDEN / SIZE 1,20 MT		20	10
26		Kİ 261	Çift Kol Lanyard Kolon Halatlı Karabinalı + Büyük Kancalı 1,20 MT Double Arm Webbing Lanyard (Carabiner + Big Hook) EN 354 - EN 362	BEDEN / SIZE 1,20 CM		30	10
27		Kİ 371	Çift Kol Lanyard Elastik Halatlı Karabinalı Büyük Kancalı 1,20 MT Double Arm with Elastic Lanyard (Carabiner+Big Hook) EN 354 - EN 362	BEDEN / SIZE 1,20 CM		20	10













S.NO	ÜRÜN RESİMİ PHOTO	ÜRÜN KODU PRODUCT CODE	ÜRÜN ADI PRODUCT NAME	UZUNLUK / LENGHT BEDEN / SIZE	FIYAT SORUNUZ	KOLI ADETİ PCS	KDV %
TEK KOLLU ŞOK EMİCİLİ STATİK HALATLI LANYARLAR EN 354							
<i>SINGLE ARM SHOCK ABSORBER With STATIC ROPE LANYARDS</i>							
28		KA 300	Şok Emici Gövde Shock Absorbing Body EN 355	BEDEN / SIZE 1 ADET		30	10
29		KA 381	Tek Kol Lanyard Şok Emici Statik Halatlı 1,20 MT Single Arm - Shock Absorber Lanyard (Static Lanyard 1,20 m EN 354 - EN 362	BEDEN / SIZE 1,20 MT		30	10
30		KA 383	Tek Kol Lanyard Şok Emici Statik Halatlı Çift Karabinalı 1,20 MT Single Arm - Shock Absorber Lanyard (with Static Lanyard and with Double Carabiner) EN 354 - EN 362	BEDEN / SIZE 1,20 MT		30	10
31		KA 385	Tek Kol Şok Emici Lanyard Statik Halatlı Çift Küçük Kancalı 1,20 MT Single Arm - Shock Absorber Lanyard EN 354 - EN 362	BEDEN / SIZE 1,20 MT		30	10
32		KA 387	Tek Kol Şok Emici Lanyard Statik Halatlı Karabinalı + Küçük Kancalı 1,20 MT Single Arm - Shock Absorber Lanyard EN 354 - EN 362	BEDEN / SIZE 1,20 MT		30	10
33		KA 388	Tek Kol Şok Emici Lanyard Statik Halatlı Karabinalı + Büyük Kancalı 1,20 MT Single Arm - Shock Absorber Lanyard (with Static Lanyard and with Carabiner + Big Hook) EN 354 - EN 362	BEDEN / SIZE 1,20 MT		30	10
34		KA 389	Tek Kol Şok Emici Lanyard Statik Halatlı Küçük + Büyük Kancalı 1,20 MT Single Arm - Shock Absorber Lanyard (with Static Lanyard and with Small Hook + Big Hook) EN 354 - EN 362	BEDEN / SIZE 1,20 MT		30	10
TEK KOLLU ŞOK EMİCİLİ KOLON HALATLI LANYARLAR EN 354							
<i>SINGLE ARM SHOCK ABSORBER WEBBING LANYARDS</i>							
35		KA 321	Tek Kol Şok Emici Lanyard Kolon Halatlı 1,20 MT Single Arm Shock Absorbing Webbing Lanyard EN 354 - EN 362	BEDEN / SIZE 1,20 MT		30	10
36		KA 323	Tek Kol Şok Emici Lanyard Kolon Halatlı Çift Karabinalı 1,20 MT Single Arm Shock Absorbing Webbing Lanyard with Double Carabiner EN 354 - EN 362	BEDEN / SIZE 1,20 MT		30	10
37		KA 325	Tek Kol Şok Emici Lanyard Kolon Halatlı Çift Küçük Kancalı 1,20 MT Single Arm Shock Absorbing Webbing Lanyard with Double Small Hook EN 354 - EN 362	BEDEN / SIZE 1,20 MT		30	10
38		KA 327	Tek Kol Şok Emici Lanyard Kolon Halatlı Karabinalı + Küçük Kancalı 1,20 MT Single Arm Shock Absorbing Webbing Lanyard (with Carabiner + Small Hook) EN 354 - EN 362	BEDEN / SIZE 1,20 MT		30	10
39		KA 328	Tek Kol Şok Emici Lanyard Kolon Halatlı Karabinalı + Büyük Kancalı 1,20 MT Single Arm Shock Absorbing Webbing Lanyard (with Carabiner + Big Hook) EN 354 - EN 362	BEDEN / SIZE 1,20 MT		30	10
40		KA 329	Tek Kol Şok Emici Lanyard Kolon Halatlı Küçük + Büyük Kancalı 1,20 MT Single Arm Shock Absorbing Webbing Lanyard (with Small Hook + Big Hook) EN 354 - EN 362	BEDEN / SIZE 1,20 MT		30	10













S.NO	ÜRÜN RESİMİ PHOTO	ÜRÜN KODU PRODUCT CODE	ÜRÜN ADI PRODUCT NAME	UZUNLUK / LENGHT BEDEN / SIZE	FIYAT SORUNUZ	KOLİ ADETİ PCS	KDV %
TEK KOLLU ŞOK EMİCİLİ ELASTİK HALATLI LANYARDLAR EN 354 SINGLE ARM SHOCK ABSORBER WEBBING ELASTIC LANYARDS							
41		KA 391	Tek Kol Şok Emici Elastik Halatlı Lanyard 1,20 MT <i>Single Arm with Shock Absorber Elastic Lanyard</i> EN 354 - EN 362	BEDEN / SIZE 1,20 MT		30	10
42		KA 393	Tek Kol Şok Emici Elastik Halatlı Lanyard Çift Karabinalı 1,20 MT <i>Single Arm with Shock Absorber Elastic Lanyard</i> (with Double Carabiner) EN 354 - EN 362	BEDEN / SIZE 1,20 MT		30	10
43		KA 395	Tek Kol Şok Emici Elastik Halatlı Lanyard Çift Küçük Kancalı 1,20 mt <i>Single Arm with Shock Absorber Elastic Lanyard</i> (with Double Small Hook) 1,20 mt EN 354 - EN 362	BEDEN / SIZE 1,20 MT		30	10
44		KA 397	Tek Kol Şok Emici Elastik Halatlı Lanyard Karabinalı + Küçük Kancalı 1,20 mt <i>Single Arm with Shock Absorber Elastic Lanyard</i> (with Carabiner + Small Hook) 1,20 mt EN 354 - EN 362	BEDEN / SIZE 1,20 MT		30	10
45		KA 398	Tek Kol Şok Emici Elastik Halatlı Lanyard Karabinalı + Büyük Kancalı 1,20 mt <i>Single Arm with Shock Absorber Elastic Lanyard</i> (with Carabiner + Big Hook) 1,20 mt EN 354 - EN 362	BEDEN / SIZE 1,20 MT		30	10
46		KA 398 A	Tek Kol Şok Emici Elastik Halatlı Lanyard Karabinalı + Alüminyum Kancalı 63'lük 1,20 mt <i>Single Arm with Shock Absorber Elastic Lanyard</i> (with Carabiner + Alüminyum Hook) 1,20 mt EN 354 - EN 362	BEDEN / SIZE 1,20 MT		30	10
47		KA 399	Tek Kol Şok Emici Elastik Halatlı Lanyard Küçük Kancalı + Büyük Kancalı 1,20 mt <i>Single Arm with Shock Absorber Elastic Lanyard</i> (with Small Hook + Big Hook) 1,20 mt EN 354 - EN 362	BEDEN / SIZE 1,20 MT		30	10
48		KA 399 A	Tek Kol Şok Emici Elastik Halatlı Lanyard Küçük Kancalı + Alüminyum Kancalı 63'lük 1,20 mt <i>Single Arm with Shock Absorber Elastic Lanyard</i> (with Small Hook + Big Hook) 1,20 mt EN 354 - EN 362	BEDEN / SIZE 1,20 MT		30	10

S.NO	ÜRÜN RESİMİ PHOTO	ÜRÜN KODU PRODUCT CODE	ÜRÜN ADI PRODUCT NAME	UZUNLUK / LENGHT BEDEN / SIZE	FIYAT SORUNUZ	KOLİ ADETİ PCS	KDV %
BAĞLAMA LANYARDLARI STATİK HALATLI & KANCALI EN 354 WORK POSITIONING LANYARDS with STATIC ROPE and with HOOKS							
49		Kİ 280 - 1,20	Tek Kol Statik Lanyard 1,20 mt <i>Single Arm Static Lanyard 1.20 mt</i> EN 354	BEDEN / SIZE 1,20 MT		30	10
50		Kİ 280 -1,50 - 2	Tek Kol Statik Lanyard 1,50 - 2 mt <i>Single Arm Static Lanyard 1,50 - 2,00 MT</i> EN 354	BEDEN / SIZE 1,50 MT		30	10
51		Kİ 281 - 1,20	Tek Kol Statik Lanyard Boğatalı 1,20 mt. <i>Single Arm Static Lanyard with 1.20 mt.</i> EN 354	BEDEN / SIZE 1,20 MT		30	10
52		Kİ 281 - 1,50	Tek Kol Statik Lanyard Boğatalı 1,50 mt. <i>Single Arm Static Lanyard with 1.50 mt.</i> EN 354	BEDEN / SIZE 1,50 MT		30	10
53		Kİ 281 - 2,00	Tek Kol Statik Lanyard Boğatalı 2,00 mt. <i>Single Arm Static Lanyard with 2,00 mt.</i> EN 354	BEDEN / SIZE 2,00 MT		30	10
54		Kİ 283	Tek Kol Statik Lanyard 1,20 mt. Çift Karabinalı <i>Single Arm Static Lanyard with Double Carabiner 1,20 mt.</i> EN 354	BEDEN / SIZE 1,20 MT		30	10
55		Kİ 285	Tek Kol Statik Lanyard Çift Küçük kancalı 1,20 mt <i>Single Arm Static Lanyard with Double Small Hook 1.20 mt</i> EN 354 - EN 362	BEDEN / SIZE 1,20 MT		30	10
56		Kİ 287	Tek Kol Statik Lanyard Karabinalı + Tek Küçük kancalı 1,20 mt <i>Single Arm Static Lanyard with Small Hook + Carabiner</i> 1.20 mt EN 354 - EN 362	BEDEN / SIZE 1,20 MT		30	10
57		Kİ 288	Tek Kol Statik Lanyard Karabina + Büyük kancalı 1,20 mt <i>Single Arm Static Lanyard with Carabiner and</i> with Big Hook 1.20 mt EN 354 - EN 362	BEDEN / SIZE 1,20 MT		30	10
58		Kİ 288 A	Tek Kol Statik Lanyard Karabina + Alüminyum kancalı 63'lük 1,20 mt <i>Single Arm Static Lanyard with Carabiner and</i> with Alüminyum Big Hook 1.20 mt EN 354 - EN 362	BEDEN / SIZE 1,20 MT		30	10
59		Kİ 289	Tek Kol Statik Lanyard Küçük + Büyük kancalı 1,20 mt <i>Single Arm Static Lanyard with Small Hook + Big Hook</i> 1.20 mt EN 354 - EN 362	BEDEN / SIZE 1,20 MT		30	10
60		Kİ 290	Tek Kol Elektrikçi Statik Lanyard İzoleli Kancalı 1,20 mt. <i>Electrician's Lanyard Large hook insulated 1.20 mt.</i> EN 354 - EN 362	BEDEN / SIZE 1,20 MT		2	10

S.NO	ÜRÜN RESİMİ PHOTO	ÜRÜN KODU PRODUCT CODE	ÜRÜN ADI PRODUCT NAME	UZUNLUK / LENGHT BEDEN / SIZE	FİYAT SORUNUZ	KOLİ ADETİ PCS	KDV %
TEK KOL LANYARD KOLON DANDAN KANCALI EN 354 <i>Single Arm Lanyard with Hook</i>							
61		Kİ 221	Tek Kol Lanyard Kolon Halatlı 1,20 mt <i>Single Arm Webbing Lanyard 1.20 mt EN 354</i>	BEDEN / SIZE 1,20 CM		30	10
62		Kİ 223	Tek Kol Lanyard Kolon Halatlı Çift Karabinalı 1,20 mt <i>Single Arm Webbing Lanyard with Double Carabiners EN 354 - EN 362</i>	BEDEN / SIZE 1,20 CM		30	10
63		Kİ 225	Tek Kol Lanyard Kolon Halatlı Çift Küçük Kancalı 1,20 mt <i>Single Arm Webbing Lanyard with Double Small Hook 1.20 mt EN 354 - EN 362</i>	BEDEN / SIZE 1,20 CM		30	10
64		Kİ 227	Tek Kol Lanyard Kolon Halatlı Karabinalı + Küçük Kancalı 1,20 mt <i>Single Arm Webbing Lanyard with Double Small Hook 1.20 mt EN 354 - EN 362</i>	BEDEN / SIZE 1,20 CM		30	10
65		Kİ 228	Tek Kol Lanyard Kolon Halatlı Karabinalı + Büyük Kancalı 1,20 mt <i>Single Arm Webbing Lanyard with Carabiner + with Big Hook. EN 354 - EN 362</i>	BEDEN / SIZE 1,20 CM		30	10
66		Kİ 228 A	Tek Kol Lanyard Kolon Halatlı Karabinalı + Alüminyum Kancalı 63'lük 1,20 mt <i>Single Arm Webbing Lanyard with Carabiner + Alüminyum Hook. EN 354 - EN 362</i>	BEDEN / SIZE 1,20 CM		30	10
67		Kİ 229	Tek Kol Lanyard Kolon Halatlı Küçük Kancalı + Büyük Kancalı 1,20 mt <i>Single Arm Webbing Lanyard with Small Hook + Big Hook 1.20 mt EN 354 - EN 362</i>	BEDEN / SIZE 1,20 CM		30	10
BAĞLAMA LANYARDLARI ELASTİK HALATLI KANCALI EN 354 <i>WORK POSITIONING ELASTIC LANYARDS with HOOK</i>							
68		Kİ 391	Tek Kol Lanyard Elastik Halatlı 1,20 mt. <i>Single Arm elastic Lanyard 1,20 mt EN 354</i>	BEDEN / SIZE 1,20 CM		30	10
69		Kİ 393	Tek Kol Lanyard Elastik Halatlı 1,20 mt Çift Karabinalı 1,20 mt. <i>Single Arm Elastic Lanyard with Double Carabiner EN 354 - EN 362</i>	BEDEN / SIZE 1,20 CM		30	10
70		Kİ 395	Tek Kol Lanyard Elastik Halatlı 1,20 mt Çift Küçük Kancalı 1,20 mt. <i>Single Arm Elastic Lanyard 1.20 mt. with Double Small Hook EN 354 - EN 362</i>	BEDEN / SIZE 1,20 CM		30	10
71		Kİ 397	Tek Kol Lanyard Elastik Halatlı 1,20 mt Karabinalı + Küçük Kancalı 1,20 mt. <i>Single Arm Elastic Lanyard 1.20 mt with Small Hook + Carabiner EN 354 - EN 362</i>	BEDEN / SIZE 1,20 CM		30	10
72		Kİ 398	Tek Kol Lanyard Elastik Halatlı 1,20 mt Karabinalı + Büyük Kancalı 1,20 mt. <i>Single Arm Elastic Lanyard 1.20 mt with Carabiner + with Big Hook EN 354 - EN 362</i>	BEDEN / SIZE 1,20 CM		30	10
73		Kİ 398 A	Tek Kol Lanyard Elastik Halatlı 1,20 mt Karabinalı + Alüminyum Kancalı 63'lük 1,20 mt. <i>Single Arm Elastic Lanyard 1.20 mt with Carabiner + with Alüminyum Hook EN 354 - EN 362</i>	BEDEN / SIZE 1,20 CM		30	10
74		Kİ 399	Tek Kol Lanyard Elastik Halatlı 1,20 mt Küçük Kancalı + Büyük Kancalı 1,20 mt. <i>Single Arm Elastic Lanyard 1.20 mt with Small Hook + Big Hook EN 354 - EN 362</i>	BEDEN / SIZE 1,20 CM		30	10

S.NO	ÜRÜN RESİMİ PHOTO	ÜRÜN KODU PRODUCT CODE	ÜRÜN ADI PRODUCT NAME	UZUNLUK / LENGHT BEDEN / SIZE	FİYAT SORUNUZ	KOLİ ADETİ PCS	KDV %
KONUMLANDIRMA LANYARDI KANCALI EN 358 <i>WORK POSITIONING LANYARDS with HOOK</i>							
75		Kİ 243	Konulandırma Lanyardı Ayarlı Kolondan 2,5 mt <i>Positioning Lanyard Adjustable with webbing 2,5mt EN 358</i>	BEDEN / size 2,5 MT		10	10
76		Kİ 244	Konulandırma Lanyardı Ayarlı 2,5 mt - 12 mm <i>Positioning Lanyard Adjustable with Static Rope 12 mm EN 358</i>	BEDEN / size 2,5 MT		10	10
77		Kİ 244 K	Konulandırma Lanyardı Ayarlı 2,5 mt - 12 mm <i>Positioning Lanyard Adjustable with Static Rope 12mm with Double Carabiner EN 358</i>	BEDEN / size 2,5 MT		10	10
78		Kİ 245	Konulandırma Lanyardı 2,5 mt - 12 mm Düşüş Tutuculu <i>Positioning Lanyard with Static Rope and with rope gripper + Double Carabiner 12 mm EN 358</i>	BEDEN / size 2,5 MT		10	10
79		Kİ 245 K	Konulandırma Lanyardı 2,5 mt - 12 mm Düşüş Tutuculu + Çift Karabinalı <i>Positioning Lanyard with Static Rope and with rope gripper + with Double Carabiner 12 mm EN 358</i>	BEDEN / size 2,5 MT		10	10
80		Kİ 248	Konulandırma Lanyardı 3 mt 12 mm Halat tutuculu <i>Positioning Lanyard 3 mt -12 mm (Rope Gripper + Double Carabiner) EN 358</i>	BEDEN / size 3 MT		10	10
81		Kİ 248 - 1	Konulandırma Lanyardı 3 mt 12 mm Halat tutuculu + Çift Karabinalı <i>Positioning Lanyard 3 mt -12 mm (Rope Gripper + Double Carabiner) EN 358</i>	BEDEN / size 3 MT		10	10
82		Kİ 248 - 2	Konulandırma Lanyardı 3 mt 12 mm Halat Tutuculu Karabinalı + Küçük Kancalı <i>Positioning Lanyard 3 mt - 12mm (Rope Gripper with Carabiner + Small Hook) EN 358</i>	BEDEN / size 3 MT		10	10
83		Kİ 248 - 3	Konulandırma Lanyardı 3 mt 12 mm Halat Tutuculu + Karabinalı + Büyük Kancalı <i>Positioning Lanyard 3 mt - 12 mm (With Rope Gripper + Carabiner + Big Hook) EN 358</i>	BEDEN / size 3 MT		10	10
84		Kİ 248 - 4	Konulandırma Lanyardı 3 mt 12 mm Halat Tutuculu + Karabinalı + Alüminyum Kancalı <i>Positioning Lanyard 3 mt - 12 mm (Rope Gripper + Carabiner + Alüminyum Hook) EN 358</i>	BEDEN / size 3 MT		10	10
85		Kİ 185	KONUMLANDIRMA BOĞUMU <i>POSITIONING NODE</i>	BEDEN / size 1 TK.		10	10

S.NO	ÜRÜN RESİMİ PHOTO	ÜRÜN KODU PRODUCT CODE	ÜRÜN ADI PRODUCT NAME	UZUNLUK / LENGHT BEDEN / SIZE	FIYAT SORUNUZ	KOLI ADETİ PCS	KDV %
ANKRAJ HALATLARI EN 795 ANCHOR LINES							
86		KB 804	Ankraj Sapanı 1 mt Anchor Sling 1 mt KARAM EN 795	BEDEN / SIZE 1 MT		10	10
87		KB 804 - 1,5	Ankraj Sapanı 1,5 mt Anchor Sling 1,5 mt KARAM EN 795	BEDEN / SIZE 1,5 MT		10	10
88		KB 804 - 2	Ankraj Sapanı 2 mt Anchor Sling 2 mt KARAM EN 795	BEDEN / SIZE 2 MT		10	10
89		KB 807	Perlon Perlon KARAM EN 795	BEDEN / SIZE 50 cm - 1 mt - 1,5 mt - 2 mt		10	10
MOBİL YATAY YAŞAM HATLARI ÇANTALI EN 795 HORIZONTAL LIFE LINE with BAG.							
90		KY 3000 - 20	Mobil Yatay Yaşam Hattı 20 mt Çantalı Mobile Horizontal Life Line - 20 mt with Bag EN 795	BEDEN / SIZE 20 MT		5	10
91		KY 3000 A	Mobil Yatay Yaşam Hattı 20 mt Çantalı + Ankrj Sapanlı 2mt Mobile Horizontal Life Line - 20 mt with Bag With 2 mt Anchor Sling EN 795	BEDEN / SIZE 20 MT		5	10
92		KY 3001 - 30	Mobil Yatay Yaşam Hattı 30 mt Çantalı Mobile Horizontal Life Line - 30 mt with Bag EN 795	BEDEN / SIZE 30 MT		5	10
93		KY 3001 A	Mobil Yatay Yaşam Hattı 30 mt Çantalı + Ankrj Sapanlı 2 mt Mobile Horizontal Life Line - 30 mt With 2 mt Anchor Sling Bag EN 795	BEDEN / SIZE 30 MT		5	10
STATİK HALATLAR EN 1891 STATIC ROPES							
94		KH 34	Statik Halat Polyester 12 mm Static Rope Polyester 12 mm EN 1891	BEDEN / SIZE 200 - 500 MT		2	10
95		KH 35	Statik Halat Polyester 14 mm Static Rope Polyester 14 mm EN 1891	BEDEN / SIZE 200 MT		2	10
96		KH 36	Statik Halat Polyester 16 mm Static Rope Polyester 16mm EN 1891	BEDEN / SIZE 200 MT		2	10
97		KH 50	İp Koruyucu Kılıf Rope Protector Sleeve	BEDEN / SIZE MT		2	10
98		KH 100	İp Koruyucu Kılıf Takviyeli 1,20 mt. Rope Protector Sleeve Reinforced	BEDEN / SIZE 1,20 MT		2	10











S.NO	ÜRÜN RESİMİ PHOTO	ÜRÜN KODU PRODUCT CODE	ÜRÜN ADI PRODUCT NAME	UZUNLUK / LENGHT BEDEN / SIZE	FIYAT SORUNUZ	KOLI ADETİ PCS	KD V%
12 MM MOBİL DİKEY YAŞAM HALATLARI 12 MM EN 353-2 MOBILE LIFE LINES 12 mm							
99		KY 2003-10 mt	Mobil Dikey Yaşam halatı 12 mm Statik Halatlı 10 mt Şok Emici+Karabina+Halat Tutucu Static lanyard Life Line 10 mt - With Shock Absorber with Carabiner and with Rope Grab. EN 353-2	BEDEN / SIZE 10 MT		5	10
100		KY 2003-15 mt	Mobil Dikey Yaşam halatı 12 mm Statik Halatlı 15 mt Şok Emici+Karabina+Halat Tutucu Static lanyard Life Line 15 mt - With Shock Absorber with Carabiner and with Rope Grab. EN 353-2	BEDEN / SIZE 15 MT		5	10
101		KY 2003-20 mt	Mobil Dikey Yaşam halatı 12 mm Statik Halatlı 20 mt Şok Emici + Karabina + Halat Tutucu Static lanyard Life Line 20 mt - With Shock Absorber with Carabiner and with Rope Grab. EN 353-2	BEDEN / SIZE 20 MT		5	10
102		KY 2003-25 mt	Mobil Dikey Yaşam halatı 12 mm Statik Halatlı 25 mt Şok Emici + Karabina + Halat Tutucu Static lanyard Life Line 25 mt - With Shock Absorber with Carabiner and with Rope Grab. EN 353-2	BEDEN / SIZE 25 MT		5	10
103		KY 2003-30 mt	Mobil Dikey Yaşam halatı 12 mm Statik Halatlı 30 mt Şok Emici+Karabina+Halat Tutucu Static lanyard Life Line 30 mt - With Shock Absorber with Carabiner and with Rope Grab. EN 353-2	BEDEN / SIZE 30 MT		5	10
104		KY 2003-50 mt	Mobil Dikey Yaşam halatı 12 mm Statik Halatlı 50 mt Şok Emici+Karabina+Halat Tutucu Static lanyard Life Line 50 mt - With Shock Absorber with Carabiner and with Rope Grab. EN 353-2	BEDEN / SIZE 50 MT		5	10
105		KY 2003-75 mt	Mobil Dikey Yaşam halatı 12 mm Statik Halatlı 75 mt Şok Emici+Karabina+Halat Tutucu Static lanyard Life Line 75 mt - With Shock Absorber with Carabiner and with Rope Grab. EN 353-2	BEDEN / SIZE 75 MT		2	10
106		KY 2003-100 mt	Mobil Dikey Yaşam halatı 12 mm Statik Halatlı 100 mt Şok Emici+Karabina+Halat Tutucu Static lanyard Life Line 100 mt - With Shock Absorber with Carabiner and with Rope Grab. EN 353-2	BEDEN / SIZE 100 MT		2	10
107		KY 2003-125 mt	Mobil Dikey Yaşam halatı 12mm Statik Halatlı 125 mt Şok Emici+Karabina+Halat Tutucu Static lanyard Life Line 125 mt - With Shock Absorber with Carabiner and with Rope Grab. EN 353-2	BEDEN / SIZE 125 MT		2	10
108		KY 2003-150 mt	Mobil Dikey Yaşam halatı 12mm Statik Halatlı 150 mt Şok Emici,Karabina, Halat tutucu Static lanyard Life Line 150 mt - With Shock Absorber with Carabiner and with Rope Grab. EN 353-2	BEDEN / SIZE 150 MT		2	10
109		KY 2003-175 mt	Mobil Dikey Yaşam halatı 12mm Statik Halatlı 175 mt Şok Emici,Karabina, Halat tutucu Static lanyard Life Line 175 mt - With Shock Absorber with Carabiner and with Rope Grab. EN 353-2	BEDEN / SIZE 175 MT		2	10
110		KY 2003-200 mt	Mobil Dikey Yaşam halatı 12mm Statik Halatlı 200 mt Şok Emici,Karabina, Halat tutucu Static lanyard Life Line 200 mt - With Shock Absorber with Carabiner and with Rope Grab. EN 353-2	BEDEN / SIZE 200 MT		2	10

S.NO	ÜRÜN RESİMİ PHOTO	ÜRÜN KODU PRODUCT CODE	ÜRÜN ADI PRODUCT NAME	UZUNLUK / LENGHT BEDEN / SIZE	FIYAT SORUNUZ	KOLI ADETI PCS	KDV %
14 MM MOBİL DİKEY YAŞAM HALATLARI 14 MM EN 353-2 MOBILE LIFE LINES 14 mm							
111		KY 2003-10 mt	Mobil Dikey Yaşam halatı 14 mm Statik Halatlı 10 mt Şok Emici+Karabina+Halat Tutucu <i>Static lanyard Life Line 10 mt - With Shock Absorber with Carabiner and with Rope Grab.</i> EN 353-2	BEDEN / SIZE 10 MT		5	10
112		KY 2003-15 mt	Mobil Dikey Yaşam halatı 14 mm Statik Halatlı 15 mt Şok Emici+Karabina+Halat Tutucu <i>Static lanyard Life Line 15 mt - With Shock Absorber with Carabiner and with Rope Grab.</i> EN 353-2	BEDEN / SIZE 15 MT		5	10
113		KY 2003-20 mt	Mobil Dikey Yaşam halatı 14 mm Statik Halatlı 20 mt Şok Emici + Karabina + Halat Tutucu <i>Static lanyard Life Line 20 mt - With Shock Absorber with Carabiner and with Rope Grab.</i> EN 353-2	BEDEN / SIZE 20 MT		5	10
114		KY 2003-25 mt	Mobil Dikey Yaşam halatı 14 mm Statik Halatlı 25 mt Şok Emici + Karabina + Halat Tutucu <i>Static lanyard Life Line 25 mt - With Shock Absorber with Carabiner and with Rope Grab.</i> EN 353-2	BEDEN / SIZE 25 MT		5	10
115		KY 2003-30 mt	Mobil Dikey Yaşam halatı 14 mm Statik Halatlı 30 mt Şok Emici+Karabina+Halat Tutucu <i>Static lanyard Life Line 30 mt - With Shock Absorber with Carabiner and with Rope Grab.</i> EN 353-2	BEDEN / SIZE 30 MT		5	10
116		KY 2003-50 mt	Mobil Dikey Yaşam halatı 14 mm Statik Halatlı 50 mt Şok Emici+Karabina+Halat Tutucu <i>Static lanyard Life Line 50 mt - With Shock Absorber with Carabiner and with Rope Grab.</i> EN 353-2	BEDEN / SIZE 50 MT		5	10
117		KY 2003-75 mt	Mobil Dikey Yaşam halatı 14 mm Statik Halatlı 75 mt Şok Emici+Karabina+Halat Tutucu <i>Static lanyard Life Line 75 mt - With Shock Absorber with Carabiner and with Rope Grab.</i> EN 353-2	BEDEN / SIZE 75 MT		2	10
118		KY 2003-100 mt	Mobil Dikey Yaşam halatı 14 mm Statik Halatlı 100 mt Şok Emici+Karabina+Halat Tutucu <i>Static lanyard Life Line 100 mt - With Shock Absorber with Carabiner and with Rope Grab.</i> EN 353-2	BEDEN / SIZE 100 MT		2	10
119		KY 2003-125 mt	Mobil Dikey Yaşam halatı 14 mm Statik Halatlı 125 mt Şok Emici+Karabina+Halat Tutucu <i>Static lanyard Life Line 125 mt - With Shock Absorber with Carabiner and with Rope Grab.</i> EN 353-2	BEDEN / SIZE 125 MT		2	10
120		KY 2003-150 mt	Mobil Dikey Yaşam halatı 14 mm Statik Halatlı 150 mt Şok Emici, Karabina, Halat tutucu <i>Static lanyard Life Line 150 mt - With Shock Absorber with Carabiner and with Rope Grab.</i> EN 353-2	BEDEN / SIZE 150 MT		2	10
121		KY 2003-175 mt	Mobil Dikey Yaşam halatı 14 mm Statik Halatlı 175 mt Şok Emici, Karabina, Halat tutucu <i>Static lanyard Life Line 175 mt - With Shock Absorber with Carabiner and with Rope Grab.</i> EN 353-2	BEDEN / SIZE 175 MT		2	10
122		KY 2003-200 mt	Mobil Dikey Yaşam halatı 14 mm Statik Halatlı 200 mt Şok Emici, Karabina, Halat tutucu <i>Static lanyard Life Line 200 mt - With Shock Absorber with Carabiner and with Rope Grab.</i> EN 353-2	BEDEN / SIZE 200 MT		2	10









S.NO	ÜRÜN RESİMİ PHOTO	ÜRÜN KODU PRODUCT CODE	ÜRÜN ADI PRODUCT NAME	UZUNLUK / LENGHT BEDEN / SIZE	FIYAT SORUNUZ	KOLI ADETI PCS	KDV %
KARABİNA & KANÇALAR EN 362 CONNECTORS							
123		KK 111	Çelik Otomatik 3 kdm. Karabina 25 kN <i>Steel Automatic 3-stage Carabiner 25 kN EN 362</i>	BEDEN / SIZE 1 ADET			20
124		KK 112	Çelik Vidalı Karabina 25 kN <i>Steel Screw Carabiner 25 kN EN 362</i>	BEDEN / SIZE 1 ADET		100	20
125		KK 113	Çelik Otomatik 2 kdm. Karabina 25 kN <i>Steel automatic 2-stage carabiner 25 kN EN 362</i>	BEDEN / SIZE 1 ADET		20	20
126		KK 119	Alüminyum Karabina 2 Kademe 25 kN <i>Aluminium Carabiner 2-stage</i>	BEDEN / SIZE 1 ADET		20	20
127		KK 121	Çelik Küçük Çift Emniyetli Kanca 23 kN <i>Steel Small hook with double safety</i>	BEDEN / SIZE 1 ADET		20	20
128		KK 131	Çelik Büyük Çift Emniyetli Kanca 25 kN 55 mm <i>Steel Large - with Double Safety Hook 25 kN 55 mm EN 362</i>	BEDEN / SIZE 1 ADET		40	20
129		KK 132	Kule Kanca Çelik 23 kN <i>Tower Hook Steel</i>	BEDEN / SIZE 1 ADET		10	20
130		KK 136	Alüminyum Büyük Çift Emniyetli Kanca 63 mm 23 kN <i>Aluminum Large with Double Safety Hook 23 kN EN 362</i>	BEDEN / SIZE 1 ADET		20	20
131		KK 138	Alüminyum Büyük Çift Emniyetli Kanca 23 kN 110mm KARAM <i>Aluminum Large with Double Safety Hook 23 kN 110mm EN 362</i>	BEDEN / SIZE 1 ADET		10	20
132		KK 166	Elektrikçi Kancası Siyah izoleli 23 kN <i>Electrician's Hook Black- insulated 23 kN EN 362 KARAM</i>	BEDEN / SIZE 1 ADET		2	20
DÜŞÜŞ DURDURUCULAR EN 353-2 FALL STOPPERS							
133		KK 01	İp Halat Tutucu Menteşeli 15kN 14-16 mm <i>Rope Gripper with Hinged - 15kN (14-16 mm) EN 353-2</i>	BEDEN / SIZE 1 ADET			20
134		KK 02	Paslanmaz Çelik Halat Tutucu 8 mm 15 kN <i>Stainless Steel Rope Gripper (8 mm) 15 kN EN 353-2</i>	BEDEN / SIZE 1 ADET		10	20
135		KK 03	İp Halat Tutucu 15kN 12-16 mm <i>Rope Gripper 15kN (12-16 mm) YOKE EN 353-2</i>	BEDEN / SIZE 1 ADET		45	20

S.NO	ÜRÜN RESİMİ PHOTO	ÜRÜN KODU PRODUCT CODE	ÜRÜN ADI PRODUCT NAME	UZUNLUK / LENGHT BEDEN / SIZE	FIYAT SORUNUZ	KOLİ ADETİ PCS	KDV %
ANKRAJLAR EN 795 ANCHORS							
136		KT 800	Tripod Tk. Tripod SET EN 795	BEDEN / SIZE 1 ADET		1	20
137		KA 20	Ankraj Kulağı 12mm (Paslanmaz 3mm) 25 kN KARAM Bolt Hanger 12 mm (Stainless 3 mm) 25 kN KARAM EN 795	BEDEN / SIZE 1 ADET		50	20
138		KA 24	Ankraj Kulağı 12 mm (Çelik 5mm) 25 kN KARAM Bolt Hanger 12 mm (Steel 5 mm) 25 kN KARAM EN 795	BEDEN / SIZE 1 ADET		100	20
139		KA 21	Ankraj Dübeli 12 mm Anchor Dowel 12 mm	BEDEN / SIZE 1 ADET		20	20
140		KA 11	Beton Çapası Anraji Parapet Anchor EN 795	BEDEN / SIZE 1 ADET		1	20
141		KA 15	Kolon Ankraj KARAM Column Anchorage KARAM EN 795	BEDEN / SIZE 1 ADET		2	20
DÜŞÜŞ TUTUCULAR - YOYO EN 360 RETRACTABLE FALL ARRESTER BLOCKS							
142		KD 2,5	Düşüş Tutucu 2,5 mt Retractable Fall Arrester Block 2,5 mt EN 360	BEDEN / SIZE 2,5 MT		1	20
143		KD 3,5	Düşüş Tutucu 3,5 mt Retractable Fall Arrester Block 3,5 mt EN 360	BEDEN / SIZE 3,5 MT		1	20
144		KD 06	Düşüş Tutucu 6 mt HARU Retractable Fall Arrester Block 6 MT HARU EN 360	BEDEN / SIZE 6 MT		2	20
145		KD 10	Düşüş Tutucu 10 mt HARU Retractable Fall Arrester Block 10 MT HARU EN 360	BEDEN / SIZE 10 MT		2	20
146		KD 15	Düşüş Tutucu 15 mt HARU Retractable Fall Arrester Block 15 MT HARU EN 360	BEDEN / SIZE 15 MT		2	20
147		KD 20	Düşüş Tutucu 20 mt HARU Retractable Fall Arrester Block 20 MT HARU EN 360	BEDEN / SIZE 20 MT		2	20
148		KD 25	Düşüş Tutucu 25 mt HARU Retractable Fall Arrester Block 25 MT HARU EN 360	BEDEN / SIZE 25 MT		2	20
149		KD 30	Düşüş Tutucu 30 mt HARU Retractable Fall Arrester Block 30 MT HARU EN 360	BEDEN / SIZE 30 MT		2	20

S.NO	ÜRÜN RESİMİ PHOTO	ÜRÜN KODU PRODUCT CODE	ÜRÜN ADI PRODUCT NAME	UZUNLUK / LENGHT BEDEN / SIZE	FIYAT SORUNUZ	KOLİ ADETİ PCS	KDV %
POLYESTER KOLONLAR WEBING							
150		KW 01	Polyester kolon 45 mm Siyah 70 gr. Polyester Webbing 45 mm Black 70 gr.	BEDEN / SIZE 100 MT		10	10
151		KW 02	Polyester kolon 45 mm Gri 65 gr. Polyester Webbing 45 mm Grey 65 gr.	BEDEN / SIZE 100 MT		10	10
152		KW 03	Polyester kolon 45 mm Turuncu 65 gr. Polyester Webbing 45 mm Orange 65 gr.	BEDEN / SIZE 100 MT		10	10
153		KW 04	Polyester kolon 45 mm Kırmızı 65 gr. Polyester Webbing 45 mm Red 65 gr.	BEDEN / SIZE 100 MT		10	10
154		KW 05	Polyester kolon 45 mm Mavi 65 gr. Polyester Webbing 45 mm Blue 65 gr.	BEDEN / SIZE 100 MT		10	10
155		KW 06	Polyester kolon 30 mm Sarı 65 gr. Polyester Webbing 30 mm Yellow 65 gr.	BEDEN / SIZE 100 MT		10	10
156		KW 07	Araç Emniyet Kemer kolonu 47 mm Siyah 57 gr. Car Webbing 47 mm Black 57 gr.	BEDEN / SIZE 100 MT		10	10
158							
SPANZET							
159		KS 10	SPANZET 10 MT TURUNCU Stretching 10 mt. ORANGE	BEDEN / SIZE 10 MT		20	20
160		KS 11	SPANZET 10 MT (EMNİYET KEMERİNDEN) Stretching 10 mt. (From the seat belt)	BEDEN / SIZE 10 MT		20	20
161							
162							

S.NO	ÜRÜN RESİMİ PHOTO	ÜRÜN KODU PRODUCT CODE	ÜRÜN ADI PRODUCT NAME	UZUNLUK / LENGHT BEDEN / SIZE	FIYAT SORUNUZ	KOLİ ADETİ PCS	KDV %
BARETLER EN 397							
HELMET							
177		KB 505	Baret Normal KARAM Safety <i>Helmet Normal</i> KARAM EN 397	BEDEN / SIZE 1 ADET		30	20
178		KB 580	Baret Vidalı (Ayarlı) KARAM Safety <i>Helmet with Screw</i> KARAM EN 397	BEDEN / SIZE 1 ADET		25	20
179		KB 586	Baret Yedek İçlik Normal (Spare Inner for KB 505) KARAM	BEDEN / SIZE 1 ADET		30	20
180		KB 588	Baret Yedek İçlik Ayarlı (Spare Inner for KB 580) KARAM	BEDEN / SIZE 1 ADET		25	20
181		KB 585	Yedek Çenebağ Spare Chin Strap	BEDEN / SIZE 1 ADET		100	10
182		KB 587	Yedek Çenebağ Çelikli Spare Chin Strap	BEDEN / SIZE 1 ADET		100	10
183		KB 610	Baret Normal Kulaklık Takılabilir Safety <i>Helmet Headset can be worn</i> KARAM EN 397	BEDEN / SIZE 1 ADET		30	20
184		KB 660	Baret Vidalı (Ayarlı) Kulaklık Takılabilir Safety <i>Helmet adjustable headphones can be worn</i> KARAM EN 397	BEDEN / SIZE 1 ADET		25	20
185		KB 591	Yedek içlik Ayarlı (Kulaklık Takılır Baret İçin) (Spare Inner for KB 660) KARAM	BEDEN / SIZE 1 ADET		25	20
186							
187							
188		KM 350	TAPKEP DARBE EMİCİ ŞAPKA EN 812	BEDEN / SIZE 1 ADET		50	10
189							

S.NO	ÜRÜN RESİMİ PHOTO	ÜRÜN KODU PRODUCT CODE	ÜRÜN ADI PRODUCT NAME	UZUNLUK / LENGHT BEDEN / SIZE	FIYAT SORUNUZ	KOLİ ADETİ PCS	KDV %
POLYESTER KOLONLAR							
WEBİNG							
150		KW 01	Polyester kolon 45 mm Siyah 70 gr. Polyester Webbing 45 mm Black 70 gr.	BEDEN / SIZE 100 MT		10	10
151		KW 02	Polyester kolon 45 mm Gri 65 gr. Polyester Webbing 45 mm Grey 65 gr.	BEDEN / SIZE 100 MT		10	10
152		KW 03	Polyester kolon 45 mm Turuncu 65 gr. Polyester Webbing 45 mm Orange 65 gr.	BEDEN / SIZE 100 MT		10	10
153		KW 04	Polyester kolon 45 mm Kırmızı 65 gr. Polyester Webbing 45 mm Red 65 gr.	BEDEN / SIZE 100 MT		10	10
154		KW 05	Polyester kolon 45 mm Mavi 65 gr. Polyester Webbing 45 mm Blue 65 gr.	BEDEN / SIZE 100 MT		10	10
155		KW 06	Polyester kolon 30 mm Sarı 65 gr. Polyester Webbing 30 mm Yellow 65 gr.	BEDEN / SIZE 100 MT		10	10
156		KW 07	Araç Emniyet Kemer kolonu 47 mm Siyah 57 gr. Car Webbing 47 mm Black 57 gr.	BEDEN / SIZE 100 MT		10	10
158							
SPANZET							
159		KS 10	SPANZET 10 MT TURUNCU Stretching 10 mt. ORANGE	BEDEN / SIZE 10 MT		20	20
160		KS 11	SPANZET 10 MT (EMNİYET KEMERİNDEN) Stretching 10 mt. (From the seat belt)	BEDEN / SIZE 10 MT		20	20
161							
162							

S.NO	ÜRÜN RESİMİ PHOTO	ÜRÜN KODU PRODUCT CODE	ÜRÜN ADI PRODUCT NAME	UZUNLUK / LENGHT BEDEN / SIZE	FIYAT SORUNUZ	KOLİ ADETİ PCS	KDV %
BARETLER EN 397							
HELMET							
163		KB 505	Baret Normal KARAM Safety <i>Helmet Normal</i> KARAM EN 397	BEDEN / SIZE 1 ADET		30	20
164		KB 580	Baret Vidalı (Ayarlı) KARAM Safety <i>Helmet with Screw</i> KARAM EN 397	BEDEN / SIZE 1 ADET		25	20
165		KB 586	Baret Yedek İçlik Normal (Spare Inner for KB 505) KARAM	BEDEN / SIZE 1 ADET		30	20
166		KB 588	Baret Yedek İçlik Ayarlı (Spare Inner for KB 580) KARAM	BEDEN / SIZE 1 ADET		25	20
167		KB 585	Yedek Çenebağı Spare Chin Strap	BEDEN / SIZE 1 ADET		100	10
168		KB 587	Yedek Çenebağı Çenelikli Spare Chin Strap	BEDEN / SIZE 1 ADET		100	10
169		KB 610	Baret Normal Kulaklık Takılabilir Safety <i>Helmet Headset can be worn</i> KARAM EN 397	BEDEN / SIZE 1 ADET		30	20
170		KB 660	Baret Vidalı (Ayarlı) Kulaklık Takılabilir Safety <i>Helmet adjustable headphones can be worn</i> KARAM EN 397	BEDEN / SIZE 1 ADET		25	20
171		KB 591	Yedek içlik Ayarlı (Kulaklık Takılır Baret İçin) (Spare Inner for KB 660) KARAM	BEDEN / SIZE 1 ADET		25	20
172							
173							
174		KM 350	TAPKEP DARBE EMİCİ ŞAPKA EN 812	BEDEN / SIZE 1 ADET		50	10
175							

S.NO	ÜRÜN RESİMİ PHOTO	ÜRÜN KODU PRODUCT CODE	ÜRÜN ADI PRODUCT NAME	UZUNLUK / LENGHT BEDEN / SIZE	FIYAT SORUNUZ	KOLİ ADETİ PCS	KDV %
ŞİPERLİKLER EN 16321-1 E							
FACE SHIELDS							
190		KM 515	BARETE TAKILABİLİR BRAKET	BEDEN / SIZE 1 ADET		50	20
191		KM 525	YEDEK VİZÖR PET 1 MM 20*40 CM	BEDEN / SIZE 1 ADET		100	20
192		KM 526	YEDEK VİZÖR POLİKARBONAT 1 MM 20*40 CM	BEDEN / SIZE 1 ADET		100	20
193		KM 523	VİZÖR TUTUCU ALINLIK	BEDEN / SIZE 1 ADET		100	20
194		KM 522	BAŞLIK VÖZÖR TAKIM	BEDEN / SIZE 1 ADET		100	20
195		KM 530	POLİCARBONAT YÜZ KORUYUCU VİZÖR ŞEFFAF 2 MM 20*40	BEDEN / SIZE 1 ADET		50	20
196		KM 531	POLİCARBONAT YÜZ KORUYUCU VİZÖR ŞEFFAF 2 MM 20*40	BEDEN / SIZE 1 ADET		50	20
197		KM 532	POLİCARBONAT YÜZ KORUYUCU VİZÖR ŞEFFAF 2 MM 20*40	BEDEN / SIZE 1 ADET		50	20
198		KM 533	POLİCARBONAT YÜZ KORUYUCU VİZÖR ŞEFFAF 2 MM 20*40	BEDEN / SIZE 1 ADET		50	20
199		KM 534	POLİCARBONAT YÜZ KORUYUCU VİZÖR ŞEFFAF 2 MM 20*40	BEDEN / SIZE 1 ADET		50	20
200		KM 535	POLİCARBONAT YÜZ KORUYUCU VİZÖR ŞEFFAF 2 MM 20*40	BEDEN / SIZE 1 ADET		50	20
201		KM 536	POLİCARBONAT YÜZ KORUYUCU VİZÖR ŞEFFAF 2 MM 20*40	BEDEN / SIZE 1 ADET		50	20
202		KG 24	GÜRÜLTÜ ÖNLEYİCİ KULAKLIK 23 dB.	BEDEN / SIZE 1 ADET		50	20
203		KM 52	TOZ MASKESİ FFP2 ANT	BEDEN / SIZE 1 ADET		450	10

EN 13414 - 1

**"LİF ÖZLÜ" ÇELİK HALAT BASKI SAPANLAR İÇİN
GÜVENLİ ÇALIŞMA YÜK DEĞERLERİ
HALAT GRUPLARI: 6X19, 6X36 ve 8X36
SAPAN STANDARDI: EN 13414**

EN 13414 - 1

**WORKING LOAD LIMITS FOR SLINGS USING "FIBRE CORED"
ROPE OF CLASSES 6X19, 6X36 and 8X36
HAVING FERRULE-SECURED EYE TERMINATIONS
SLING STANDARD: EN 13414**

Tip Type	Tek bacak 1 leg	Boğdurma Choker hitch	Sepet sapan Basket sling		2 bacaklı 2 legs		Bağdurma 2 bacaklı Choker hitch		3 veya 4 bacaklı 3 or 4 legs slings		Sonsuz Endless	
Açı/Angle β	-	-	0° - 45°	45° - 60°	0° - 45°	45° - 60°	0° - 45°	45° - 60°	0° - 45°	45° - 60°	-	-
Bacak faktörü Leg factor	1,0	0,8	1,4	1,0	1,4	1,0	1,2	0,8	2,1	1,5	2x2	1,6
Halat çapı Rope Dia.	Kg											
8	700	560	980	700	980	700	840	560	1500	1050	2800	1100
10	1050	840	1470	1050	1470	1050	1260	840	2250	1600	4200	1700
12	1550	1240	2170	1550	2170	1550	1860	1240	3300	2300	6200	2500
13	1800	1440	2520	1800	2520	1800	2160	1440	3850	2700	7200	2900
14	2120	1700	2970	2120	2970	2120	2550	1700	4350	3150	8480	3300
16	2700	2160	3780	2700	3780	2700	3240	2160	5650	4200	10800	4350
18	3400	2720	4760	3400	4760	3400	4100	2720	7200	5200	13600	5650
20	4350	3480	6100	4350	6100	4350	5200	3480	9000	6500	17400	6900
22	5200	4160	7280	5200	7280	5200	6240	4160	11000	7800	20800	8400
24	6300	5040	8820	6300	8820	6300	7560	5040	13500	9400	25200	10000
26	7200	5760	10080	7200	10080	7200	8640	5760	15000	11000	28800	11800
28	8400	6720	11760	8400	11760	8400	10080	6720	18000	12500	33600	13500
32	11000	8800	15400	11000	15400	11000	13200	8800	23500	16500	44000	18000
36	14000	11200	19600	14000	19600	14000	16800	11200	29000	21000	56000	22500
40	17000	13600	23800	17000	23800	17000	20400	13600	36000	26000	68000	28000
44	21000	16800	29400	21000	29400	21000	25200	16800	44000	31500	84000	33500
48	25000	20000	35000	25000	35000	25000	30000	20000	52000	37000	100000	40000
52	29000	23200	40600	29000	40600	29000	34800	23200	62000	44000	116000	47000
56	33500	26800	46900	33500	46900	33500	40200	26800	71000	50000	134000	54000
60	39000	31200	54600	39000	54600	39000	46800	31200	81000	58000	156000	63000

EN 13414 - 1

**"ÇELİK ÖZLÜ" ÇELİK HALAT BASKI SAPANLAR İÇİN
GÜVENLİ ÇALIŞMA YÜK DEĞERLERİ
HALAT GRUPLARI: 6X19, 6X36 ve 8X36
SAPAN STANDARDI: EN 13414**

EN 13414 - 1

**WORKING LOAD LIMITS FOR SLINGS USING "STEEL CORED"
ROPE OF CLASSES 6X19, 6X36 and 8X36
HAVING FERRULE-SECURED EYE TERMINATIONS
SLING STANDARD: EN 13414**

Tip Type	Tek bacak 1 leg	Boğdurma Choker hitch	Sepet sapan Basket sling		2 bacaklı 2 legs		Bağdurma 2 bacaklı Choker hitch		3 veya 4 bacaklı 3 or 4 legs slings		Sonsuz Endless	
Açı/Angle β	-	-	0° - 45°	45° - 60°	0° - 45°	45° - 60°	0° - 45°	45° - 60°	0° - 45°	45° - 60°	-	-
Bacak faktörü Leg factor	1,0	0,8	1,4	1,0	1,4	1,0	1,2	0,8	2,1	1,5	2x2	1,6
Halat çapı Rope Dia.	Kg											
8	750	600	1050	750	1050	750	900	600	1550	1100	3000	1200
10	1150	920	1600	1150	1600	1150	1380	920	2400	1700	4600	1350
12	1700	1360	2300	1700	2300	1700	2040	1360	3550	2500	6800	2700
13	2000	1600	2800	2000	2800	2000	2400	1600	4150	3000	8000	3150
14	2250	1800	3150	2250	3150	2250	2700	1800	4800	3400	9000	3700
16	3000	2400	4200	3000	4200	3000	3600	2400	6300	4500	12000	4800
18	3700	2960	5200	3700	5200	3700	4440	2960	7800	5650	14800	6000
20	4600	3680	6500	4600	6500	4600	5520	3680	9800	6900	18400	7350
22	5650	4520	7800	5650	7800	5650	6780	4520	11800	8400	22600	9000
24	6700	5360	9400	6700	9400	6700	8000	5360	14000	10000	26800	10600
26	7800	6240	11000	7800	11000	7800	9360	6240	16400	11500	31200	12500
28	9000	7200	12600	9000	12600	9000	10800	7200	19000	13500	36000	14500
32	11800	9440	16500	11800	16500	11800	14160	9440	25000	17500	47200	19000
36	15000	12000	21000	15000	21000	15000	18000	12000	31500	22500	60000	23500
40	18500	14800	26000	18500	26000	18500	22200	14800	39000	28000	74000	30000
44	22500	18000	31500	22500	31500	22500	27000	18000	47000	33500	90000	36000
48	26000	20800	37000	26000	37000	26000	31200	20800	55000	40000	104000	42000
52	31500	25200	44000	31500	44000	31500	37800	25200	66000	47000	126000	50000
56	36000	28800	50000	36000	50000	36000	43200	28800	76000	54000	144000	58000
60	42000	33600	58000	42000	58000	42000	50400	33600	88000	63000	168000	67000

DIN 3088 STANDARINDA UYGUN SAPAN ÇEŞİTLERİ
WIRE ROPE SLING Acc. To DIN 3088

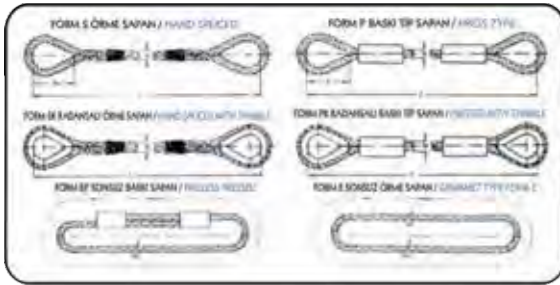

GÖZ TIPLERİ VE BOYUTLARI
EYE TYPES AND DIMENSIONS

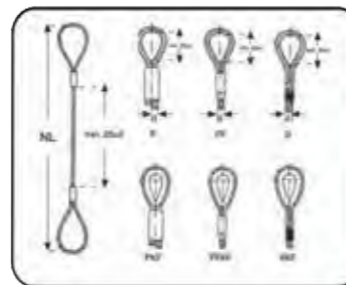

EN 13411-3 STANDARINDA UYGUN BASKI TIPLERİ
PRESSING TYPES Acc. to EN 13411-3

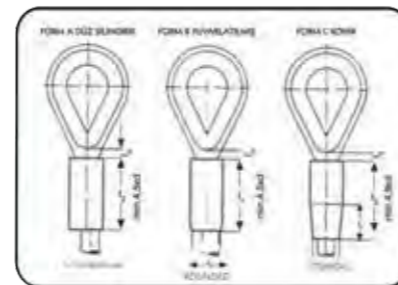

SERTİFİKALARIMIZ



BELEGE NUMARASI REFERENCE NUMBER OF LICENCE	060849-TSE-01/02
BELEGENİN İLK VERİLİŞ TARİHİ DATE OF FIRST ISSUE OF LICENCE	29.04.2016
BELEGENİN SON GEÇERLİLİK TARİHİ LICENCE VALID UNTIL	05.04.2025
BELEGE SAHİBİ KURULUŞUN ADI NAME OF THE LICENCE HOLDER	ERK ÇELİK HALAT SANAYİ VE TİCARET ANONİM ŞİRKETİ
BELEGE SAHİBİ KURULUŞUN ADRESİ ADDRESS OF THE LICENCE HOLDER	DERİ OSB MAH. ALSANCAK SK. NO:4/1 TUZLA İSTANBUL/TÜRKİYE
ÜRETİM YERİ ADI NAME OF THE MANUFACTURING PLACE	ERK ÇELİK HALAT VE DEMİR MAMÜLLERİ SANAYİ VE TİCARET A.Ş.
ÜRETİM YERİ ADRESİ ADDRESS OF THE MANUFACTURING PLACE	İDOSB ALSANCAK SK İ-3 PARSEL NO 4 ORHANLI TUZLA İSTANBUL / TÜRKİYE
İPTAL EDİLEN BELEGE NUMARASI (Varsa) INDICATION OF SUPERSEDED LICENCE (if any)	060849-TSE-01/01
TESCİLLİ TİCARİ MARKASI REGISTERED TRADE MARK	POWERK
İLGİLİ TÜRK STANDARTI RELATED TURKISH STANDARD	TS EN 13414-1-A2 / 09.04.2009
BELEGE KAPSAMI SCOPE OF LICENCE	* ÇELİK TEL HALAT SAPANLAR - KALİTE SINIFI: 1770 VE 1960 OLAN - 6 DİMETLİ ÇELİK ÖZLÜ / 6 DİMETLİ İF ÖZLÜ - KELEPÇELİ (SERT GÖZLÜ - YUMUŞAK GÖZLÜ) VE ÖRME GÖZ SONLANDIRICILI - 1-2-4 KÖLLÜ - 8 mm (DAHİL)DEN 60 mm (DAHİL)YE KADAR

23.05.2024
Belgeleme Merkezi Başkanı Adına
AKDOĞAN BULUT
İSTANBUL BELGELENDİRME MÜDÜRÜ V.

1 / 1

BANKA HESAP NUMARALARIMIZ

AKBANK

TL TR22 0004 6012 3588 8000 0583 71
USD TR10 0004 6012 3500 1000 0029 97
EURO TR10 0004 6012 3503 6000 0116 04



TL TR60 0006 2000 6610 0006 2930 91
USD TR98 0006 2000 6610 0009 0822 24
EURO TR85 0006 2000 6610 0009 0910 91



TL TR82 0001 2009 8550 0010 2604 48



TL TR95 0006 4000 0011 2710 2743 29



TL TR42 0006 7010 0000 0082 7541 16



ERK ÇELİK HALAT
SANAYİ VE TİCARET ANONİM ŞİRKETİ

Deri Organize Sanayi Bölgesi Mah.
Alsancak Sk. No:4/1 Tuzla / İstanbul
Tel: 444 2 987 | Faks: (216) 313 58 99
www.erkcelik.com.tr